



# RazorWeld

## OPERATING MANUAL

### Razor TIG320 ACDC



**3 YEAR** Warranty

Please read and understand this instruction manual carefully before the installation and operation of this equipment.

**Thank you for choosing to purchase this RAZORWELD Welding Machine.**

We are proud of our range of welding equipment that has a proven track record of innovation, performance and reliability. Our product range represents the latest developments in inverter technology put together by our professional team of highly skilled engineers. The expertise gained from our long involvement with inverter technology has proven to be invaluable towards the evolution and future development of our equipment range. This experience gives us the inside knowledge on what the arc characteristics, performance and interface between man and machine should be. Within our team are specialist welders that have a proven history of welding knowledge and expertise, giving vital input towards ensuring that our machines deliver control and performance to the utmost professional level. We employ an expert team of professional sales, marketing and technical personnel that provide us with market trends, market feedback and customer comments and requirements. Secondly they provide a customer support service that is second to none, thus ensuring our customers have confidence that they will be well satisfied both now and in the future.

RAZORWELD welders are manufactured and compliant with - CAN/CSA E60974-1 & ANSI/IEC 60974-1, AS/NZ60974-1 guaranteeing you electrical safety and performance.

## **WARRANTY**

- 3 Years from date of purchase.
- Esseti NZ Ltd warranties all goods as specified by the manufacturer of those goods.
- This Warranty does not cover freight or goods that have been interfered with.
- All goods in question must be repaired by an authorised repair agent as appointed by this company.
- Warranty does not cover abuse, mis-use, accident, theft, general wear and tear.
- New product will not be supplied unless Esseti NZ Ltd has inspected product returned for warranty and agree to replace product.
- Product will only be replaced if repair is not possible
- Please view full Warranty term and conditions supplied with machine or at the back of this manual.

## **ATTENTION! - CHECK FOR GAS LEAKS**

At initial set up and at regular intervals we recommend to check for gas leakage.

Recommended procedure is as follows:

1. Connect the regulator and gas hose assembly and tighten all connectors and clamps.
2. Slowly open the cylinder valve.
3. Set the flow rate on the regulator to approximately 8-10 l/min.
4. Close the cylinder valve and pay attention to the needle indicator of the contents pressure gauge on the regulator, if the needle drops away towards zero there is a gas leak.  
Sometimes a gas leak can be slow and to identify it will require leaving the gas pressure in the regulator and line for an extended time period. In this situation it is recommended to open the cylinder valve, set the flow rate to 8-10 l/min, close the cylinder valve and check after a minimum of 15 minutes.
5. If there is a gas loss then check all connectors and clamps for leakage by brushing or spraying with soapy water, bubbles will appear at the leakage point.
6. Tighten clamps or fittings to eliminate gas leakage.

**IMPORTANT! - We strongly recommend that you check for gas leakage prior to operation of your machine. We recommend that you close the cylinder valve when the machine is not in use.**

**Esseti NZ Ltd, authorised representatives or agents of Esseti NZ Ltd will not be liable or responsible for the loss of any gas.**

<b>CONTENTS</b>	<b>PAGE</b>
Warranty - Gas Leak Prevention	2
Safety - Precautions	4-6
Electrical Schematic Diagram	7
Machine Data Technical Specifications	8-9
Machine Layout Description	10-11
Front Panel Functions	12
Front Panel Operation - Weld Program Selection & Setting	13-18
MMA Weld Program - Set Up Procedure	19
Remote Controls and Water Cooler Modes	20
Job Select, Job Save, Job Recall, Job Delete	21
MMA (stick) Welding Set Up Procedure	22-23
MMA (stick) Welding Fundamentals	24-25
Installation & Operation for DC TIG Welding	26
DC TIG Welding - Standard Set Up Procedure - Operation	27-28
Weld Start Procedure for DC, AC/DC, MIX ARC Welding	28
DC TIG Welding	29
DC Pulse TIG Welding	30
DC PULSE TIG Welding - Set Up Procedure - Operation	31
TIG Welding Fusion and Filler Wire Technique	32
Machine Set Up for AC and MIX ARC TIG Welding	33
AC Welding - Standard Set Up Procedure - Operation	34-35
AC TIG Wave Forms	36
AC TIG Wave Form Frequency Control	36
AC TIG Wave Form Balance Control	37-38
AC PULSE TIG Welding - Set Up Procedure - Operation	39
MIX ARC Welding	40
MIX ARC Welding Set Up Procedure	40
Remote Amperage Controls - Installation and Operation	41
Tungsten Electrode Selection & Preparation	42-43
TIG Torch Parts Breakdown	44-45
Trouble Shooting Guide - TIG Welding	46-47
Trouble Shooting Guide - MMA (Stick) Welding	48
Gas Leak Warning and Check Procedure	49
Warranty Policy	50-51

# SAFETY

**Welding and cutting equipment can be dangerous to both the operator and people in or near the surrounding working area if the equipment is not correctly operated. Equipment must only be used under the strict and comprehensive observance of all relevant safety regulations. Read and understand this instruction manual carefully before the installation and operation of this equipment.**

## Machine Operating Safety

- Do not switch the function modes while the machine is operating. Switching of the function modes during welding can damage the machine. Damage caused in this manner will not be covered under warranty.
- Disconnect the electrode-holder cable from the machine before switching on the machine, to avoid arcing should the electrode be in contact with the work piece.
- Operators should be trained and or qualified.



**Electric shock: It can kill.** Touching live electrical parts can cause fatal shocks or severe burns. The electrode and work circuit is electrically live whenever the output is on. The input power circuit and internal machine circuits are also live when power is on. In Mig/Mag welding, the wire, drive rollers, wire feed housing, and all metal parts touching the welding wire are electrically live. Incorrectly installed or improperly grounded equipment is dangerous.

- Connect the primary input cable according to Australian and New Zealand standards and regulations.
- Avoid all contact with live electrical parts of the welding circuit, electrodes and wires with bare hands. The operator must wear dry welding gloves while he/she performs the welding task.
- The operator should keep the work piece insulated from himself/herself.
- Keep cords dry, free of oil and grease, and protected from hot metal and sparks.
- Frequently inspect input power cable for wear and tear, replace the cable immediately if damaged, bare wiring is dangerous and can kill.
- Do not use damaged, under sized, or badly joined cables.
- Do not drape cables over your body.



**Fumes and gases are dangerous.** Smoke and gas generated whilst welding or cutting can be harmful to people's health. Welding produces fumes and gases. Breathing these fumes and gases can be hazardous to your health.

- Do not breathe the smoke and gas generated whilst welding or cutting, keep your head out of the fumes
- Keep the working area well ventilated, use fume extraction or ventilation to remove welding fumes and gases. Use of a PAPR system is recommended.
- In confined or heavy fume environments always wear an approved air-supplied respirator. Welding fumes and gases can displace air and lower the oxygen level causing injury or death. Be sure the breathing air is safe.
- Do not weld in locations near de-greasing, cleaning, or spraying operations. The heat and rays of the arc can react with vapours to form highly toxic and irritating gases.
- Materials such as galvanized, lead, or cadmium plated steel, containing elements that can give off toxic fumes when welded. Do not weld these materials unless the area is very well ventilated, and or wearing an air supplied respirator.



**Arc rays: harmful to people's eyes and skin.** Arc rays from the welding process produce intense visible and invisible ultraviolet and infrared rays that can burn eyes and skin.

- Always wear a welding helmet with correct shade of filter lens and suitable protective clothing including welding gloves whilst the welding operation is performed.
- Measures should be taken to protect people in or near the surrounding working area. Use protective screens or barriers to protect others from flash, glare and sparks; warn others not to watch the arc.



**Fire hazard.** Welding on closed containers, such as tanks, drums, or pipes, can cause them to explode. Flying sparks from the welding arc, hot work piece, and hot equipment can cause fires and burns. Accidental contact of electrode to metal objects can cause sparks, explosion, overheating, or fire. Check and be sure the area is safe before doing any welding.

- The welding sparks may cause fire, therefore remove any flammable materials away from the working area, at least 12m from the welding arc. Cover flammable materials and containers with approved covers if unable to be moved from the welding area.
- Do not weld on closed containers such as tanks, drums, or pipes, unless they are properly prepared according to the required Safety Standards to insure that flammable or toxic vapors and substances are totally removed, these can cause an explosion even though the vessel has been “cleaned”. Vent hollow castings or containers before heating, cutting or welding. They may explode.
- Do not weld where the atmosphere may contain flammable dust, gas, or liquid vapours (such as petrol)
- Have a fire extinguisher nearby and know how to use it. Be alert that welding sparks and hot materials from welding can easily go through small cracks and openings to adjacent areas. Be aware that welding on a ceiling, floor, bulkhead, or partition can cause fire on the hidden side.



**Gas Cylinders.** Shielding gas cylinders contain gas under high pressure. If damaged, a cylinder can explode. Because gas cylinders are normally part of the welding process, be sure to treat them carefully. CYLINDERS can explode if damaged.

- Protect gas cylinders from excessive heat, mechanical shocks, physical damage, slag, open flames, sparks, and arcs.
- Ensure cylinders are held secure and upright to prevent tipping or falling over.
- Never allow the welding electrode or earth clamp to touch the gas cylinder, do not drape welding cables over the cylinder.
- Never weld on a pressurised gas cylinder, it will explode and kill you.
- Open the cylinder valve slowly and turn your face away from the cylinder outlet valve and gas regulator.



**Gas build up.** The build up of gas can causes a toxic environment, deplete the oxygen content in the air resulting in death or injury. Many gases use in welding are invisible and odourless.

- Shut off shielding gas supply when not in use.
- Always ventilate confined spaces or use approved air-supplied respirator.



**Electronic magnetic fields.** MAGNETIC FIELDS can affect Implanted Medical Devices.

- Wearers of Pacemakers and other Implanted Medical Devices should keep away.
- Implanted Medical Device wearers should consult their doctor and the device manufacturer before going near any electric welding, cutting or heating operation.



**Noise can damage hearing.** Noise from some processes or equipment can damage hearing. Wear approved ear protection if noise level is high.



**Hot parts.** Items being welded generate and hold high heat and can cause severe burns. Do not touch hot parts with bare hands. Allow a cooling period before working on the welding gun. Use insulated welding gloves and clothing to handle hot parts and prevent burns.

# CAUTION

## 1. Working Environment.

- 1.1 The environment in which this welding equipment is installed must be free of grinding dust, corrosive chemicals, flammable gas or materials etc, and at no more than maximum of 80% humidity.
- 1.2 When using the machine outdoors protect the machine from direct sun light, rain water and snow etc; the temperature of working environment should be maintained within -10°C to +40°C.
- 1.3 Keep this equipment 30cm distance from the wall.
- 1.4 Ensure the working environment is well ventilated.

## 2. Safety Tips.

### 2.1 Ventilation

This equipment is small-sized, compact in structure, and of excellent performance in amperage output. The fan is used to dissipate heat generated by this equipment during the welding operation.

**Important:** Maintain good ventilation of the louvers of this equipment. The minimum distance between this equipment and any other objects in or near the working area should be 30 cm. Good ventilation is of critical importance for the normal performance and service life of this equipment.

### 2.2 Thermal Overload protection.

Should the machine be used to an excessive level, or in high temperature environment, poorly ventilated area or if the fan malfunctions the Thermal Overload Switch will be activated and the machine will cease to operate. Under this circumstance, leave the machine switched on to keep the built-in fan working to bring down the temperature inside the equipment. The machine will be ready for use again when the internal temperature reaches safe level.

### 2.3 Over-Voltage Supply

Regarding the power supply voltage range of the machine, please refer to "Main Parameter" table.

This equipment will automatically compensate for input voltage variations within a specific range.

In circumstances where the voltage of the input power supply exceeds the stipulated value, it is | possible to cause damage to the internal components of this equipment. Please ensure your primary power supply is correct."

### 2.4 Do not come into contact with the output terminals while the machine is in operation.

An electric shock may possibly occur.

# MAINTENANCE

Exposure to extremely dusty, damp, or corrosive air is damaging to the welding machine. In order to prevent any possible failure or fault of this welding equipment, clean the dust at regular intervals with clean and dry compressed air of required pressure.

**Please note that:** lack of maintenance can result in the cancellation of the warranty; the warranty of this welding equipment will be void if the machine has been modified or shows signs of attempts to open or take apart the machine through damaging the factory-installed seal without the consent of an authorized representative of the manufacturer.

# TROUBLE SHOOTING

Caution: Only qualified technicians are authorized to undertake the repair of this welding equipment.

For your safety and to avoid Electrical Shock, please observe all safety notes and precautions detailed in this manual.

## Note:

Minimum Motor Generator Power Suggested:- 6KVA

- Our equipment as described in this manual conforms to all applicable rules and regulations of the 'LowVoltage Directive' (European Council Directive 73/23/EEC) as set out and amended by Council Directive 93/68/EEC) and to the National legislation for the enforcement of this Directive.
- Our equipment as described in this manual conforms to all applicable rules and regulations of the European Council Directive 89/336/EEC, (EMC Directive) and to the National legislation for he enforcement of this Directive.

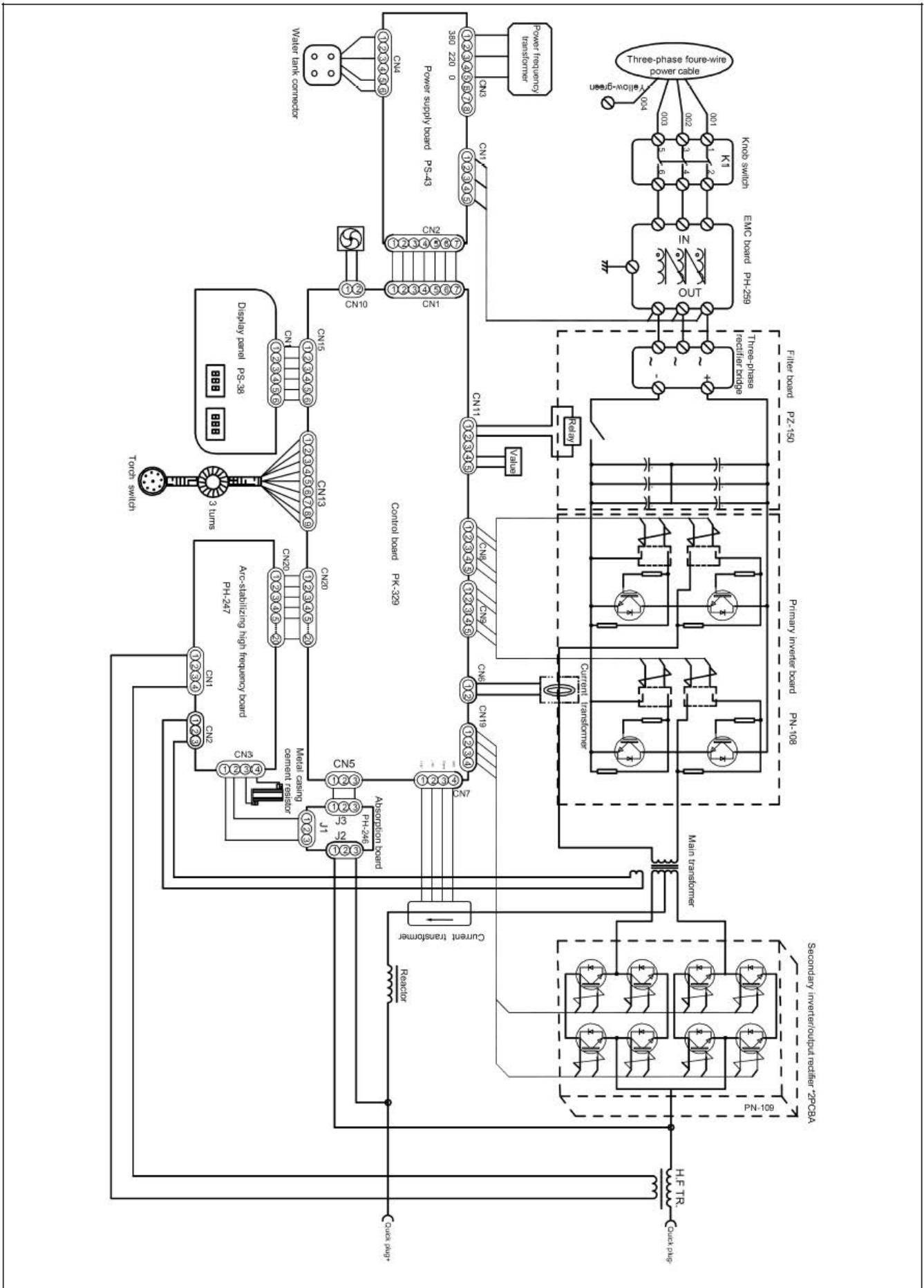

## RAZORWELD TIG320CRZ AC/DC

TIG/MMA 320 Amp 415V AC/DC Inverter Welder  
Intelligent Digital Control, 43KHz Inverter

Featuring multiple AC output waveforms of Square, Trapezoidal and Sine, combined with AC Balance and AC Frequency control you have the ultimate tool in AC TIG Welding mode to suit all your AC TIG welding requirements.

### Features

■ AC TIG

- HF Arc Ignition
- Lift Arc Ignition
- Square Wave Form
- Trapezoidal Wave Form
- Sine Wave Form
- AC Wave Frequency
 

Amps	Frequency
5~200A	50~200 Hz
200~320A	50~100 Hz
- AC Pulse Frequency
 

Amps	Frequency
5~200A	0.5~20 Hz
210~320A	0.5~10 Hz
- Pulse Width Control 5~95%
- AC Balance Control +/- 10 20~60% EN

■ DC TIG

- HF Arc Ignition
- Lift Arc Ignition
- DC Pulse Frequency
 

Amps	Frequency
5~320A	0.5~200Hz

■ MIX ARC TIG (AC-DC)

- HF Arc Ignition
- Lift Arc Ignition
- AC-DC Mix Cycle 5~95% DC
- AC Wave Frequency 50-100 Hz
- Mix Pulse Frequency 1~10 Hz

■ WELD SEQUENCE CONTROL

- Pulse Width Control 5~95%
- Start Current 5~320A
- Base Current 5~320A
- Up Slope 0~15 sec
- Down Slope 0~15 sec
- Adjustable Pre Gas 0.5~10 sec
- Adjustable Post Gas 0.5~15 sec
- Trigger Control 2T-2s ~ 4T-4s
- Remote Amp Control Optional

■ MMA (stick electrode)

- Ignition Amp 10-80A
- Ignition Time 0.01-1.5 sec
- Arc Force (adjusts arc energy to suit electrode application)



### Technical Data

Power Supply		400V 3-Phase ±15%
Rated Input Power	TIG	9.0 kVA
	MMA	10.0 kVA
Rated Output	TIG	10~320A / 10.4~22.8V
	MMA	10~270A / 20.4~30.8V
No Load Voltage		70V
VRD Voltage		12.4V
Duty Cycle @ 40°C as per AS/NZ60974-1		30% @ 320 Amps TIG
		30% @ 270 Amps MMA
Power Factor		0.70
Protection Class		IP21S
Insulation Class		F
Dimensions (LxWxH)		566 x 223 x 405mm
Weight		25.9 Kg
Certification Approval		AS/NZ60974-1



## AC WAVE FORMS

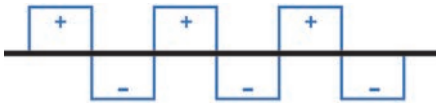

**AC Square Wave:** Allows the current to change from electrode + positive to electrode - negative very quickly. This produces high voltage as the current switches polarities allowing the arc to restart easily. The arc can be maintained without the use of high-frequency and the fast transitions provide for responsive, dynamic and focused arc for better directional control.

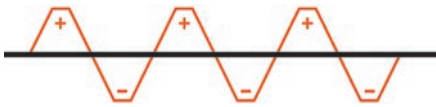

**AC Triangle Wave:** Characterised by a particularly soft and concentrated arc combining the effect of peak amperage while reducing overall heat input. Leads to quick puddle formation and, because of lowered heat input, reduced weld distortion, especially on thin material. This wave form is ideal for very precise welding of thin Aluminum plate.

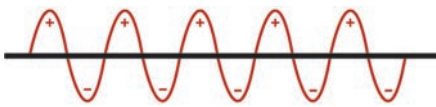

**AC Sine Wave:** It is the standard Wave form, characterised by low noise and excellent arc control, it also gives the soft-arc feel of a conventional power source, while using square transitions to eliminate the need for continuous HF.

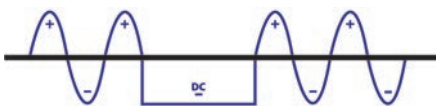

**AC MIX ARC:** This function of MIX AC/DC makes it possible to modulate the welding current, alternating a period of TIG AC with a period of TIG DC-. This means that the efficiency of AC TIG welding can be combined with the high penetration of DC TIG welding, obtaining higher welding speeds and establishing the weld puddle quicker on cold workpieces. The operator adjustable parameter is the percentage of AC waveform compared to DC- waveform over the entire period, which can be varied from 5~95%. Ideal for welding heavier gauge material with less current than AC welding.

## Overview

The Razorweld TIG320CRZ ACDC is a new generation inverter welder with a primary function of AC/DC-TIG.

**AC TIG:** Featuring multiple AC output wave forms of Square, Trapezoidal and Sine, combined with AC Balance and AC Frequency control you have the ultimate tool in AC TIG Welding mode to suit all your AC TIG welding requirements.

**DC TIG:** Latest 43KHz inverter frequency technology provides the ultimate in smooth and stable arc condition for DC TIG welding mode, coupled with the Digital Weld Sequence Program provides complete and professional DC TIG Welding function.

**MIX ARC:** This function of MIX AC/DC makes it possible to modulate the welding current, alternating a period of TIG AC with a period of TIG DC-. This means that the efficiency of AC TIG welding can be combined with the high penetration of DC TIG welding, obtaining higher welding speeds and establishing the weld puddle quicker on cold workpieces. The operator adjustable parameter is the percentage of AC waveform compared to DC- waveform over the entire period, which can be varied from 5~95%.

**MMA:** Full attention is given to MMA welding providing both DC and AC output modes. Ignition AMP and Ignition Time provides for an operator controlled Hot Start of the weld by applying extra current to the set weld current over a preset time. Arc force allows adjustment of the arc transfer from a digging action through to a softer layering effect. The complete and professional MMA function allows you to set the ideal arc condition no matter what the electrode and welding situation.

**Weld Sequence Control:** The Digital Weld Sequence Program and intelligent MCU software provides full TIG functionality in AC, DC and MIX modes. Adjustable pre-sets include Pre-Gas time, Start Current, Up Slope, Down Slope, Finish Current level and Post-Gas time. Digital Pulse parameter pre-sets include Peak & Base current; Pulse Frequency & Pulse Width. HF and LIFT Arc Ignition.

**Torch Mode:** Multiple torch trigger selections of 2T, 2S, 4T, 4S provide complete flexibility and operator control over the weld sequence from start to finish.

**Remote Control:** The Remote Interface allows connection of either Torch Remote or Foot Pedal for remote control of amperage output.

**Job Memory:** Job memory function allows you to enter and store weld parameter settings under job numbers. The job number can be recalled to reveal and use the weld parameters stored, weld parameters can be further adjusted and stored as required. A total of 50 Jobs can be memorised and stored for recall.

**Water Cooler Control:** Activating the water cooler control allows for the water cooler to operate when welding current is available during welding and will switch off automatically after 5 minutes of no welding current.

The Razorweld TIG320CRZ ACDC is a complete and professional TIG /MMA welding machine that is ideal for all high-end aluminium, stainless steel fabrication, marine and industrial engineering welding situations. Designed and built to our specification and manufactured in compliance to AS/NZ60974-1.

## Product Code: XA-TIG315RZ ACDC-K

Standard Package includes: TIG315RZ ACDC Machine, ARC T3 X 4m Tig Torch, Earth Lead & Arc Lead 25mm x 4m, Argon Regulator

Front Machine Layout Description

- 1. Digital control panel
- 2. Negative output terminal
- 3. Postive output terminal
- 4. Torch switch - Remote connector
- 5. Front Panel Assembly
- 6. Quick lock gas connector
- 7. Rotary Encoder



Rear Machine Layout Description

- 8. Power switch - on/off
- 9. Water Cooler Connector
- 10. Inlet gas connector
- 11. Water Cooler Fuse
- 12. Mains Power Cable
- 12. Rear Panel Assembly



Water Cooler Front Layout Description

- 1. Fault Alarm
- 2. On/Off Swicth
- 3. Coolant Filler
- 4. Front Panel
- 5. Water Connector Inlet
- 6. Water Connector Outlet

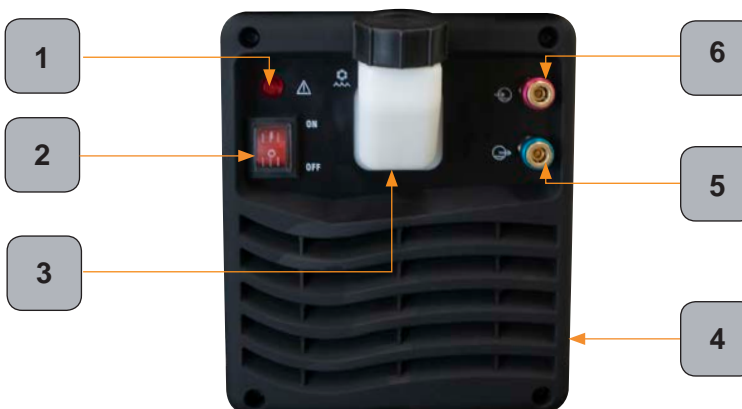

**Water Cooler Rear Layout Description**

- 1. Fault Alarm
- 2. On/Off Swithch
- 3. Coolant Filler
- 4. Front Panel
- 5. Water Connector Inlet
- 6. Water Connector Outlet



**Machine Trolley Layout Description**

- 1. Cylinder Rack
- 2. Cable Hanger
- 3. Cylinder Tray
- 4. Solid Rubber Wheel
- 5. Tig Rod Holder
- 6. Front Locking Castor Wheels
- 7. Top Tray with Handle
- 8. Machine Mounting Brackets
- 9. Optional Water Cooler

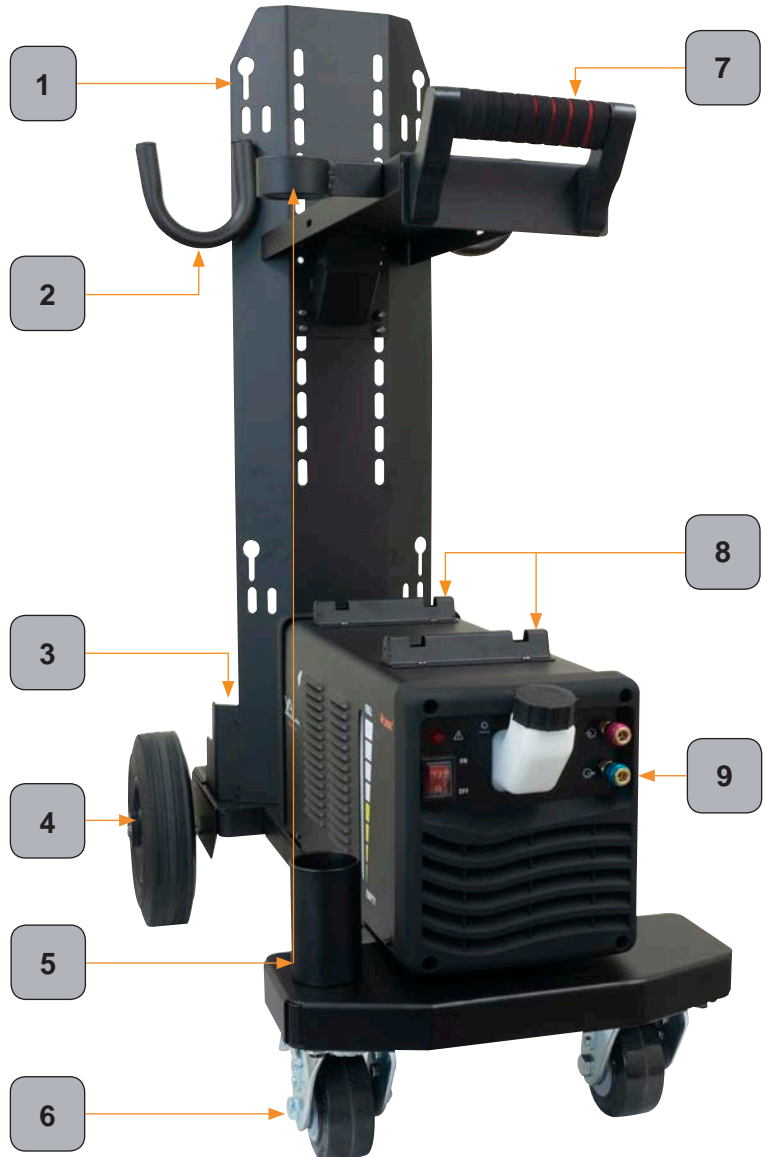

Front Panel Functions

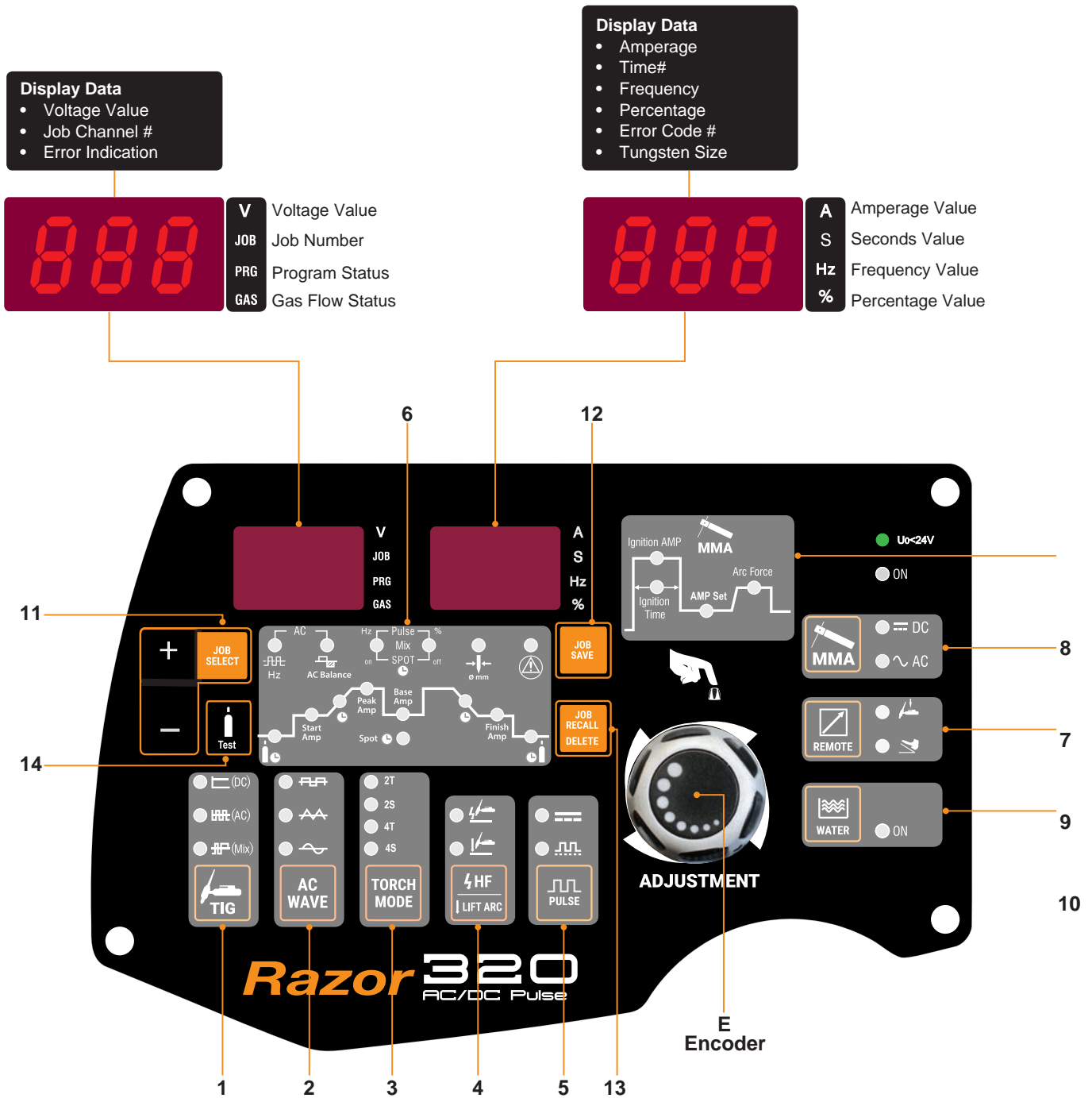

No.	SECTION DESCRIPTION	INSTRUCTION PAGE	No.	SECTION DESCRIPTION	INSTRUCTION PAGE
1.	MODE SELECT	13	8.	MMA MODE PROGRAM	19
2.	AC WAVE MODE SELECT	13	9.	REMOTE CONTROL MODE SELECT	20
3.	TORCH SWITCH MODE SELECT	13	10.	WATER COOLER MODE SELECT	20
4.	TIG ARC IGINTION SELECT	13	11.	JOB SAVE	21
5.	PULSE MODE SELECT	13	12.	JOB RECALL, DELETE SELECT	21
E	ENCODER	14	13.	JOB SELECT	21
6.	WELD SEQUENCE PROGRAM	14-18	14.	GAS TEST	21
7.	MMA - AC DC MODE SELECT	19			

**1. Mode Selector** - Enables choice of Welding Mode: DC TIG - AC TIG - MIX ARC - DC MMA (Stick) - AC MMA (Stick)



**DC Tig:** Select by pushing the  button to cycle through to illuminate the DC icon.





**AC Tig:** Select by pushing the  button to cycle through to illuminate the AC icon.



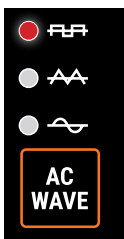

**MIX ARC Tig:** Select by pushing the  button to cycle through to illuminate the MIX icon.

**2. AC Wave Form Selection** - Enables choice of Wave Form: SQUARE WAVE - TRAPEZIODAL - SINUSOIDAL





**SQUARE WAVE:** Select by pushing the  button to cycle through to illuminate the  icon. (refer page 10 for Square Wave information)





**TRAPEZIODAL WAVE:** By pushing the  button cycle through to illuminate the  icon. (refer page 10 for Trapeziodal Wave information)



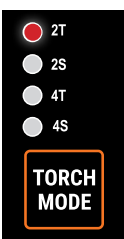

**SINUSOIDAL WAVE:** By pushing the  button cycle through to illuminate the  icon. (refer page 10 for Sinusoidal Wave information)

**3. Torch Mode Selection** - Enables choice of Torch Mode: 2T - 2S - 4T - 4S

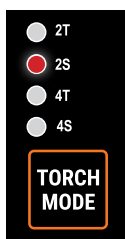

**2T:** Select by pushing the  button to cycle through to illuminate the 2T icon. (refer page 10 for instruction and use of 2T Function)



**2S:** Select by pushing the  button to cycle through to illuminate the 2S icon. (refer page 10 for instruction and use of 2S Function)

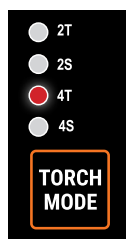

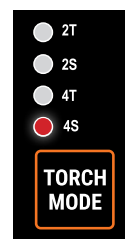

**4T:** Select by pushing the  button to cycle through to illuminate the 4T icon. (refer page 10 for instruction and use of 4T Function)





**4S:** Select by pushing the  button to cycle through to illuminate the 4S icon. (refer page 10 for instruction and use of 4S Function)

**4. Arc Ignition** - Enables choice of Arc Ignition: HF - LIFT ARC





**HF Ignition:** Select by pushing the  button to cycle through to illuminate the  icon.





**LIFT ARC Ignition:** Select by pushing the  button to cycle through to illuminate the  icon.

**5. Pulse Select** - Enables choice of Pulse Mode: Pulse Off - Pulse On



**Pulse Off:** Select by pushing the  button to cycle through to illuminate the  icon.



**Pulse On:** Select by pushing the  button to cycle through to illuminate the  icon.

### Using the ENCODER to Select Weld Program Functions and Adjust Settings



#### Weld program function selection and adjustment

Turning the encoder knob will allow cyclic step by step motion through the weld program, the encoder can be turned in both directions allowing backward and forward travel through the weld program functions. When the LED  ends on the desired function push the encoder knob, this will lock the function ready for adjustment of its parameter, the LED will blink on and off to show the function selected. Turning the encoder will allow adjustment of the parameter which will be shown in the Digital Display on the front panel of the machine.



Pushing the encoder after adjustment will set the parameter and return it to cyclic travel through the program.



**IMPORTANT:** When the encoder is in set parameter mode, ie LED blinks on and off. It will time out after 5 seconds of last use and return to cyclic mode.

#### 6A - Weld Program - Selecting weld program parameters

**Parameter selection:** Select by turning the Encoder  Knob to cycle through the weld parameter icons.

The icon will illuminate  when selected.

 Push the encoder knob to lock the icon. The LED icon will blink on and off ready for adjustment of the parameter.

Turn the Encoder  to adjust the setting. Push the Encoder  to lock the setting.

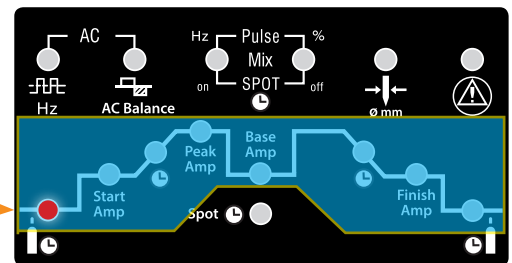

#### Pre Gas Timer - Provides selection for gas flow time prior to the arc starting.

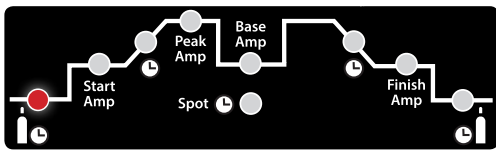

**Pre Gas Time:** Select by turning the encoder to cycle through to illuminate the Pre Gas Timer  icon.



Push the Encoder to lock the icon ready for adjustment.



Turn the Encoder to set the Pre-Gas Time (Range is 0.5-10 Sec)



The value selected shows on the digital display. It is the length of time the gas will flow before the arc starts.

#### Start Amp - Provides selection for the amount of amperage required at the start of the weld.

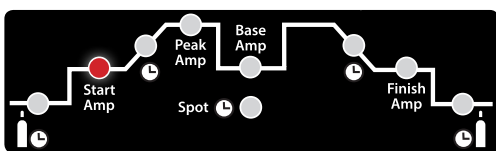

**Start Amp:** Select by pushing the encoder to cycle through to illuminate the Start Amp icon.



Push the Encoder to lock the icon ready for adjustment.





Turn the Encoder to set the Start Amp value (Range is 10-320A)

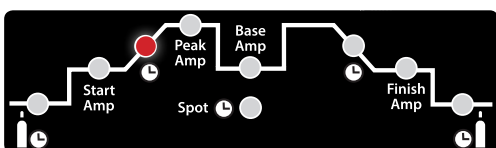

The value selected shows on the digital display. It is the amount of amps the machine will deliver at the start of the weld.

#### Up Slope Time - Sets the transition time from Start Amperage to Welding Amperage



**Up Slope Time:** Select by turning the encoder to cycle through to illuminate the Up Slope icon. 



Push the Encoder to lock the icon ready for adjustment.



Turn the Encoder to set the Up Slope value (Range is 0-15 Sec)



The set value shows on the digital display. It is the time the welding current takes to rise from start amps to welding amperage.

**Up Slope Time** - Provides selection for the amount of amps required at the start of the weld.

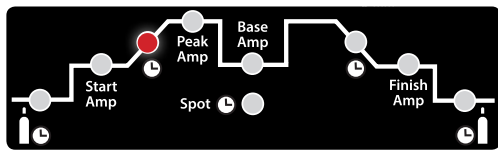

**Up Slope Time:** Select by pushing the encoder to cycle through to illuminate the Up Slope icon.

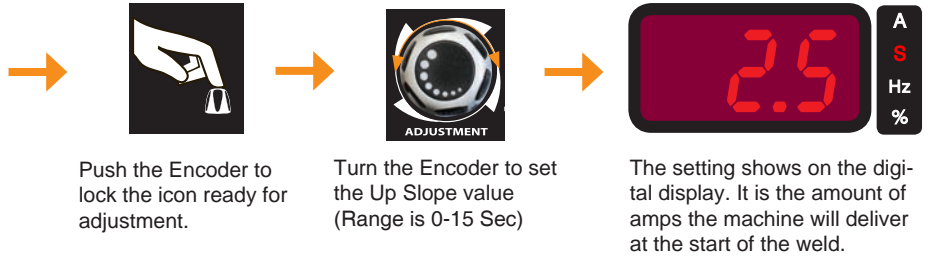

Push the Encoder to lock the icon ready for adjustment.

Turn the Encoder to set the Up Slope value (Range is 0-15 Sec)

The setting shows on the digital display. It is the amount of amps the machine will deliver at the start of the weld.

**Peak Amp** - Provides selection for the Maximum Welding Amperage required during welding.

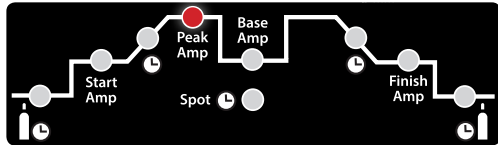

**Peak Amp:** Select by turning the encoder to cycle through to illuminate the Peak Amp icon.

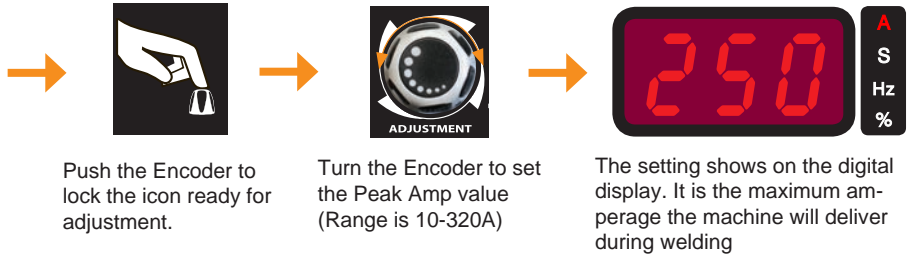

Push the Encoder to lock the icon ready for adjustment.

Turn the Encoder to set the Peak Amp value (Range is 10-320A)

The setting shows on the digital display. It is the maximum amperage the machine will deliver during welding

**Base Amp** - Provides selection for the Base Amperage during the Pulse Welding cycle.

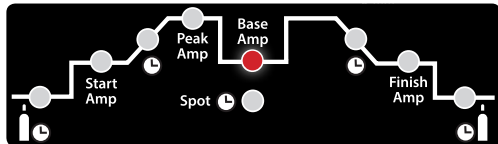

**Base Amp:** Select by turning the encoder to cycle through to illuminate the Base Amp icon.

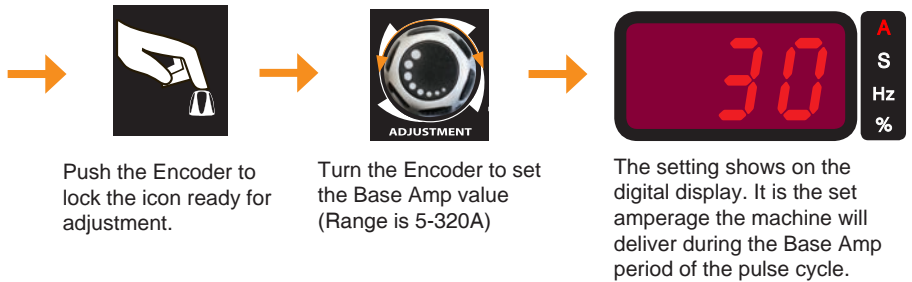

Push the Encoder to lock the icon ready for adjustment.

Turn the Encoder to set the Base Amp value (Range is 5-320A)

The setting shows on the digital display. It is the set amperage the machine will deliver during the Base Amp period of the pulse cycle.

**Down Slope Time** - Sets the transition time from Welding Amperage to Finish Amperage

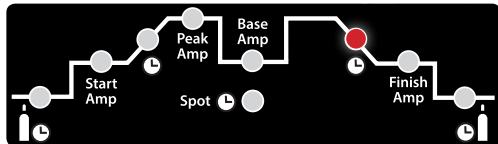

**Down Slope Time:** Select by turning the encoder to cycle through to illuminate the Down Slope icon.



Push the Encoder to lock the icon ready for adjustment.

Turn the Encoder to set the Down Slope time (Range is 0-15 Sec)

The setting shows on the digital display. It is the time taken for the welding amps to drop down to the finish amperage.

**Finish Amp** - Provides selection for the amount of amperage required at the end of the weld.

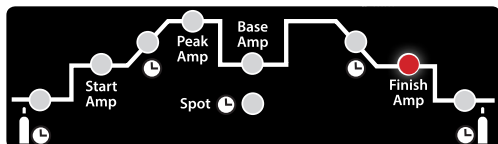

**Finish Amp:** Select by turning the encoder knob to cycle through to illuminate the Finish Amp icon.

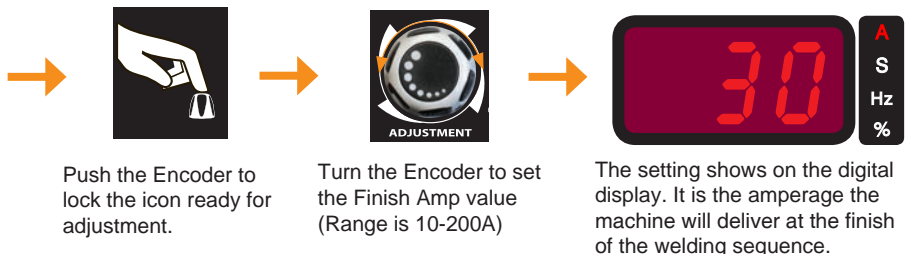

Push the Encoder to lock the icon ready for adjustment.

Turn the Encoder to set the Finish Amp value (Range is 10-200A)

The setting shows on the digital display. It is the amperage the machine will deliver at the finish of the welding sequence.

**Post Gas Timer** - Provides selection for continued gas flow time at the end of the welding after the arc is out.

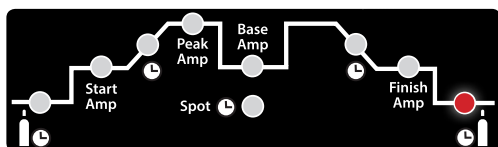

**Post Gas Time:** Select by turning the encoder knob to cycle through to illuminate the Post Gas Timer icon.



Push the Encoder to lock the icon ready for adjustment.

Turn the Encoder to set the Finish Amp value (Range is 10-200A)



The value selected shows on the digital display. It is the length of time the gas will flow after the arc is finished.

### 6A - Weld Program - Selecting more weld program parameters

**Parameter selection:** Select by turning the Encoder Knob to cycle through the weld parameter icons.

The icon will illuminate   when selected.

 Push the encoder knob to lock the icon. The LED icon will blink on and off ready for adjustment of the parameter.

Turn the Encoder  to adjust the setting. Push the Encoder  to lock the setting.

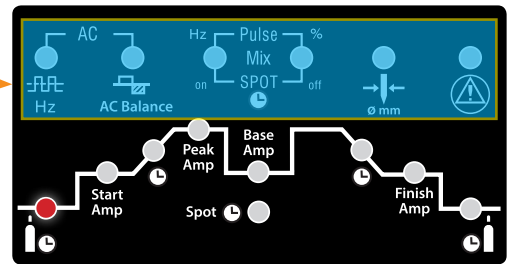

**AC Hz** - Provides selection to adjust the frequency of the AC square wave in AC TIG mode. Allows adjustment of frequency of the AC square wave cycle. The number of times per second (Hz) the arc switches from + to - polarity (AC) during AC TIG welding.

**AC Hz:** Select by turning the encoder knob to cycle through to illuminate the AC Hz  icon.

Push the Encoder to lock the icon ready for adjustment.

Turn the Encoder to set the AC Hz value (Range is 50-200Hz)

The value selected shows on the digital display. It is the number of times (Hz) the arc switches from positive to negative polarity (AC)

**AC Balance** - Provides balance adjustment of the AC wave form in AC TIG mode. Allows adjustment of the proportion of polarity from balanced, to more - polarity for penetrating action or more + for oxide cleaning action during AC TIG welding.

**AC Balance:** Select by turning the encoder knob to cycle through to illuminate the AC Balance  icon.

Push the Encoder to lock the icon ready for adjustment.

Turn the Encoder to set the AC Balance value (Range is (-5-0-5+ )

The value selected shown on the digital display represents a more penetrating arc set at -5, a balanced arc at 0, or a more oxide cleaning action arc at 5+

**Pulse Hz** - Provides selection and adjustment of the pulse frequency of the output welding current. Allows adjustment of frequency that the output current transitions from Peak Amp to Base Amp.

**Pulse Hz:** Select by turning the encoder knob to cycle through to illuminate the Hz icon.

Push the Encoder to lock the icon ready for adjustment.

Turn the Encoder to set the Pulse Frequency (Hz) value  
Range DC (0.5-200Hz)  
Range AC (0.5-20Hz)

The value selected shown on the digital display represents the number of times per second that the output welding current switches from Peak Amp to Base Amp

**% Pulse** - Provides selection of the on time ratio of the Peak Amp during the pulse welding cycle (Pulse Width) Allows adjustment of the % of time that the Peak Amp is on during each pulse cycle.

**Pulse Hz:** Select by turning the encoder knob to cycle through to illuminate the % icon.

Push the Encoder to lock the icon ready for adjustment.

Turn the Encoder to set the Pulse Frequency (Hz) value  
Range is (5-95%)

The value selected shown on the digital display represents the % of time that the Peak Amp is on during the pulse cycle.



**Tungsten Diameter** - Provides selection of the correct tungsten diameter for the set welding parameters.  
Warning Alert appears if the parameters are outside the capability of the tungsten diameter.

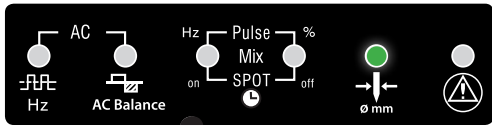

**Tungsten Diameter Select:** Select by turning the encoder knob to cycle through to illuminate the  $\varnothing$  mm icon.



Push the Encoder to lock the icon ready for adjustment.





Turn the Encoder to set the Tungsten diameter Range is (1.0 - 4.0mm)

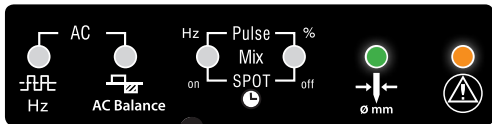

The value selected shown on the digital display represents the % of time that the Peak Amp is on during the pulse cycle.

**Tungsten Size Alert** - Appears if the parameters are outside the capability of the tungsten diameter.





The ALERT  icon will illuminate when the amperage set is outside the recommended current carrying capability of the selected tungsten diameter during **AC** and **MIX ARC** welding. The machine will operate when the Alert is on, the alert is to assist in prevention of over loading the tungsten with amperage causing it to disintegrate. Adjust the amperage down or increase the tungsten diameter to better match the tungsten diameter capability.

**6C - MIX ARC Weld Program** - Selecting MIX ARC program parameters

**Parameter selection:** Select by turning the  Encoder Knob to cycle through the weld parameter icons.

The icon will illuminate   when selected.

 Push the encoder knob to lock the icon. The LED icon will blink on and off ready for adjustment of the parameter.

Turn the Encoder  to adjust the setting. Push the Encoder  to lock the setting.

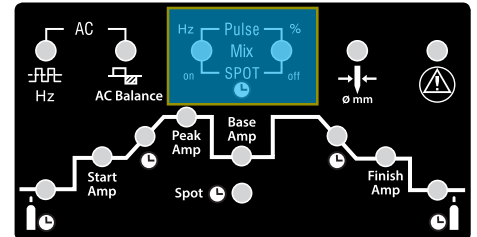

 **MIX ARC Tig:** Select by pushing the  button to cycle through to illuminate the **MIX** icon.

**MIX Hz** - Provides selection and adjustment of the frequency of AC output to DC- output during MIX ARC welding.  
Adjusts the frequency Hz (times per second) that the output current switches from AC to DC-



**MIX Hz:** Select by turning the encoder knob to cycle through to illuminate the **Hz** icon.



Push the Encoder to lock the icon ready for adjustment.



Turn the Encoder to set the MIX ARC Frequency (Hz) value Range is (1-10 Hz)



The value selected shown on the digital display represents the number of times per second that the output welding current switches from AC to DC-

**MIX %** - Provides selection and adjustment of the % of DC- output during the MIX ARC welding cycle.  
Adjusts the amount of DC- output during MIX ARC welding.

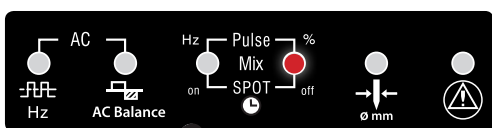

**MIX Hz:** Select by turning the encoder knob to cycle through to illuminate the **%** icon.



Push the Encoder to lock the icon ready for adjustment.



Turn the Encoder to set the MIX ARC % value Range is (5-95%)





The value selected shown on the digital display represents the % of DC- output during MIX ARC welding.

### 6D - SPOT Weld Program - Selecting SPOT Weld program parameters

**Parameter selection:** Select by turning the  Encoder Knob to cycle through the weld parameter icons.

The icon will illuminate   when selected.

 Push the encoder knob to lock the icon. The LED icon will blink on and off ready for adjustment of the parameter.

Turn the Encoder  to adjust the setting. Push the Encoder  to lock the setting.

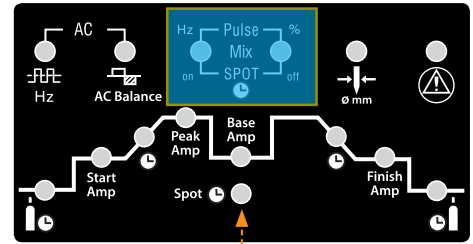



**TORCH MODE**  **SPOT WELD:** Select by pushing the  button to cycle through to illuminate the  icon.

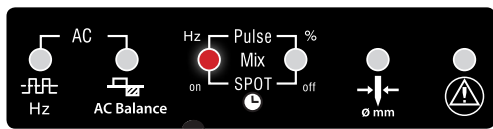

**SPOT MODE** - Selecting SPOT mode allows setting of an ON time and OFF time of the welding current. After pressing the torch switch and generating an established arc the welding current will stay on for the amount of ON TIME, (set in the SPOT weld program) the arc will go out after the set amount has passed. Keeping the torch switch depressed will allow an OFF TIME (interval) (set in the SPOT weld program) period before the arc is re-established and the welding current stays on again for the set amount of ON TIME, the cycle will repeat until the torch switch is released.

**SPOT ON TIME** - Provides selection and adjustment of the ON TIME of the weld during SPOT Weld cycle. Adjusts the amount of time the welding output stays on after arc ignition.



**SPOT ON TIME:** Select by turning the encoder knob to cycle through to illuminate the  icon.



Push the Encoder to lock the icon ready for adjustment.





Turn the Encoder to set the **SPOT ON** time value Range is (0.01 - 1.0 sec)

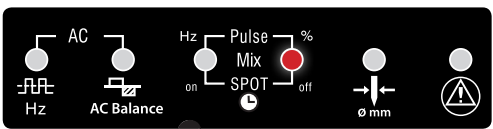

The value selected shown on the digital display represents the amount of time the welding current stays on after the trigger has been pressed and the arc established.

**SPOT OFF TIME** - Provides selection and adjustment of the OFF TIME of the weld during SPOT Weld cycle. Adjusts the amount of the OFF time interval of the welding current.



**SPOT OFF TIME:** Select by turning the encoder knob to cycle through to illuminate the  icon.



Push the Encoder to lock the icon ready for adjustment.



Turn the Encoder to set the **SPOT OFF** time value Range is (0.1 - 5.0 sec)



The value selected shown on the digital display represents the amount of time the welding current stays off during the SPOT weld cycle.

**7. MMA DC - AC MODE SELECT** - Provides selection MMA Mode (stick welding) and DC or AC Mode.



**DC MMA MODE:** Select by pushing the button to illuminate the DC icon.

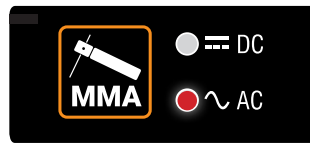

**AC MMA MODE:** Select by pushing the button to illuminate the AC icon.

**8. MMA IGNITION AMP** - Provides selection and adjustment of the electrode IGNITION start up properties. Sets the hot start striking arc current for the electrode start characteristic.

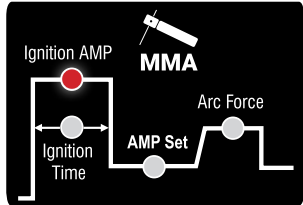

**Ignition Amp:** Select by turning the encoder knob to cycle through to illuminate the Ignition AMP icon.



Push the Encoder to lock the icon ready for adjustment.



Turn the Encoder to set the **Ignition AMP** value



The value selected shown on the digital display represents the amount AMPS Selected

**8. MMA IGNITION TIME** - Provides selection and adjustment of the electrode IGNITION Time start. Sets the time that the MMA Arc Ignition AMP time is on.

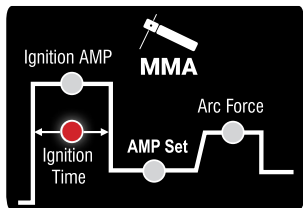

**Ignition time:** Select by turning the encoder knob to cycle through to illuminate the Ignition AMP icon.



Push the Encoder to lock the icon ready for adjustment.



Turn the Encoder to set the **Ignition time** value



The value selected shown on the digital display represents the amount AMPS Selected

**8. MMA AMP SET** - Provides selection and adjustment of welding current in MMA Mode.

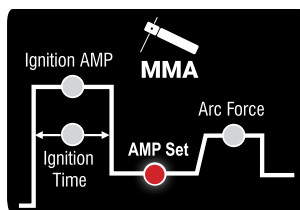

**Amp set:** Select by turning the encoder knob to cycle through to illuminate the Ignition AMP icon.



Push the Encoder to lock the icon ready for adjustment.



Turn the Encoder to set the **AMP** set value



The value selected shown on the digital display represents the amount AMPS Selected

**8. MMA Arc Force Control** - Provides selection for adjustment of the ARC FORCE during MMA (Stick) welding. Allows setting from a soft buttery arc characteristic to a more digging, penetrating arc.

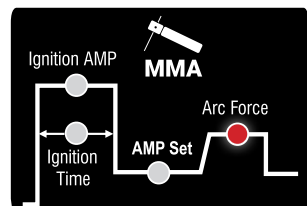

**ARC Force:** Select by turning the encoder knob to cycle through to illuminate the ARC Force icon.



Push the Encoder to lock the icon ready for adjustment.



Turn the Encoder to set the **Arc Force** value



The value selected shown on the digital display represents extra Amps applied to the electrode when short circuit is about to occur.

**REMOTE CONTROLS** - Provides selection of the type of Remote Control to be used as required. Provides option for Remote Foot Control or Remote Torch Control

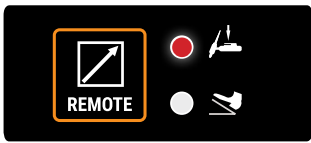

**Torch Mounted** : Select by pushing the Remote button to illuminate the torch icon.

**Foot Control**: Select by pushing the Remote button to illuminate the foot control icon.

**WATER COOLER MODE** - Provides electronic link when water cooler unit is connected to the machine.



**Water Cooler Connection**: Select by pushing the WATER button to illuminate the ON icon to enter the machine into water cooling mode.

Water Cooler Connection Socket Located at the Rear of the Power Source

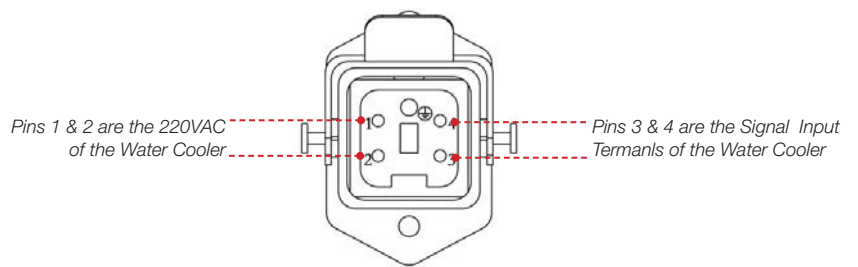

**Water Cooler Connection** - The water cooler is connected to the power source via a 5 Pin connector located at the rear of the machine. The connector provides 220-230VAC power supply to the water cooler unit via Pins 1&2. The machine will monitor the water flow and welding off time via a signal circuit connected to Pins 3&4.

**IMPORTANT NOTE:**

This sensor circuit will turn off the welding output should there be no or insufficient water flow from the water cooler unit. This will prevent the Water Cooled torch cable from over heating and burning out.

**WARNING! Prevention of Torch Cable Overheating & Burn Out**

When using RAZORWELD TIG320 ACDC machine with a Water Cooled TIG Torch ensure:

1. The water cooler is plugged into the power supply at the rear of the Power Source.
2. The water level is to the full level.
3. The water cooler is switched on using the on/off switch located on the front panel of the water cooler.
4. The power source is in Water Cooler Mode by selecting the Water On icon on the front panel.



1. Plug in the water cooler at the rear of the Power Source

2. Check the Water Level

3. Switch on the on/off switch on the front panel of the water cooler

4. Activate the Water On icon on the front panel

**Esseti NZ Ltd, authorised representatives or agents of Esseti NZ Ltd will not be liable or responsible for any damage to water cooled torch cables due to overheating and burning out.**

## JOB SELECT - JOB SAVE - JOB RECALL - JOB DELETE

Allows the operator to save the set welding parameters and assign them to a JOB number. The JOB number can be recalled later as required, the welding parameters are preserved inside the JOB number ready for use.

The welding parameters stored inside the JOB number can be DELETED as required.

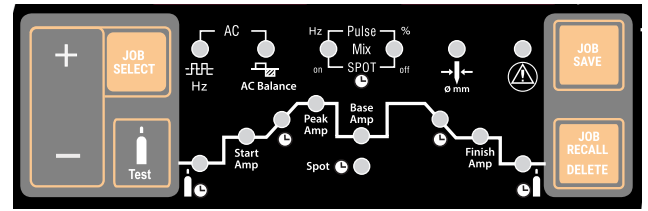

**11. JOB Select** - Allows the operator to enter the welding parameter storage mode and select the JOB number required.



**JOB select:** Select the JOB number by pushing the JOB select  button and the Gas Test button 

Test



**Forward JOB Select:** To cycle forwards through the JOB numbers. Push the JOB select button 



**Reverse JOB select:** To travel back through the JOB list. Press the Gas Test  button. (This button has dual function)



Test



The JOB number will show on the digital display.

**12. JOB SAVE** - Allows the operator to enter set welding parameters and SAVE the data to a selected JOB number.



**JOB save select:** Select a JOB number. Press the JOB select  button & the Gas Test button  to select a JOB number.

Test



**JOB number:** The selected JOB number will show on the digital display.





**JOB save:** Set welding parameters as required. To save to the selected JOB number press the JOB SAVE button 

JOB SAVE

**13. JOB RECALL** - Allows the operator to recall welding parameters saved to a JOB number.



**JOB recall select:** Select a JOB number. Press the JOB select  button & the Gas Test button  to select a JOB number. (This button has dual function)

Test





**JOB number:** The selected JOB number will show on the digital display.



**JOB recall:** Press the JOB RECALL button. The saved welding parameters will be recalled and appear on the front panel display.

**13. JOB DELETE** - Allows the operator to recall welding parameters saved to a JOB number and DELETE the data saved.



**JOB recall select:** Select a JOB number. Press the JOB select  button & the Gas Test button  to select a JOB number.

Test



**JOB number:** The selected JOB number will show on the digital display.



**JOB recall:** Press the JOB DELETE button and hold for 2 seconds.. The saved welding parameters will be deleted from the selected JOB number.

**13. GAS TEST** - Allows the operator to test and set the Gas Flow prior to welding.



**GAS TEST** - Press the GAS TEST button and the gas will Flow, press the button again and the gas will stop. The Gas Flow will time out after 20 seconds and stop if the Gas Test button is not re-pressed.

**IMPORTANT NOTE** - The GAS TEST button also serves as the Minus Cycle button function when in JOB SELECT mode



### MMA (Stick Electrode) Welding Setup and Operation

- 1. Connecting the Welding Lead Set:** Various electrodes require a different polarity for optimum results refer to the electrode manufacturers information for the correct polarity. Most GP electrodes are electrode connected to  $\ominus$  output socket, Earth Connected to the  $\oplus$  output socket
- Turn the power source on using the on/off switch located on the rear machine panel.
- Set the MMA weld settings using the MMA weld program on the front panel

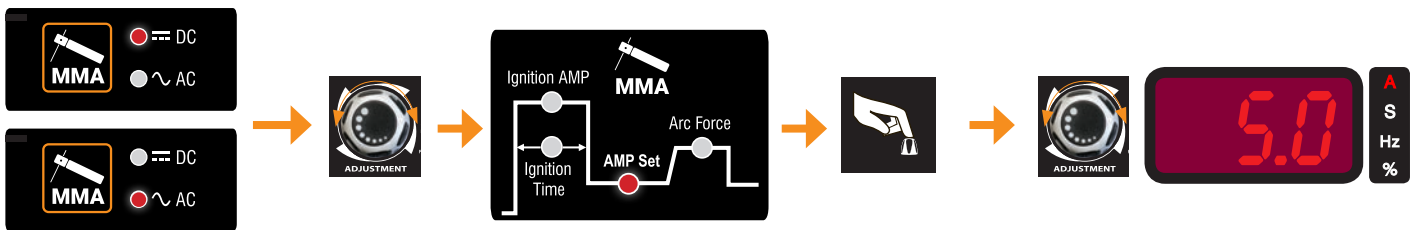

**(3)** Select DC or AC MMA Function. Push the MMA button to make your choice of DC or AC.

**(4)** Set the MMA parameters such as AMP Set, ARC Force etc, by turning the Encoder Knob until the appropriate icon illuminates.

**(5)** Push the Encoder to lock the selected icon ready for adjustment.

**(6)** Turn the Encoder to set the value of the selected icon. The value selected will show on the digital display.

Refer to Page 25 for instruction and explanation on MMA parameter selection and settings.



6) Connect the Earth Clamp securely to the work piece or the work bench.



4) Place the electrode into the electrode holder and clamp tight.



5) Strike the electrode against the work piece to create an arc and hold the electrode steady to maintain the arc



6) Hold the electrode slightly above the work piece to maintain the arc while travelling at an even speed to create and even weld deposition.



7) To finish the weld, break the arc by quickly snapping the electrode away from the work piece.

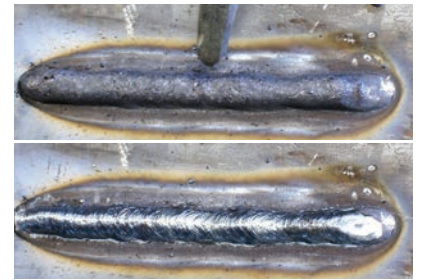

8) Wait for the weld to cool and carefully chip away the slag to reveal the weld metal below.

## IMPORTANT NOTES - For MMA (Stick) Welding

### DC MMA ELECTRODE POLARITY - What is the electrode polarity and why is it important.

When using a DC power source, the question of whether to use electrode negative or positive polarity arises.

**Direct current flows in one direction in an electrical circuit and the direction of current flow and the composition of the electrode coating will have a definite effect on the welding arc and weld bead. Refer to the electrode manufacturers recommendation for polarity choice.**

With DC electrode (+) positive (reverse) polarity, more heat is generated at the workpiece. This produces welds with deep penetration and a narrower weld bead and can reduce the incidence of lack-of-fusion defects in the weld.

DC electrode (-) negative (straight) polarity generates more heat at the electrode and produces welds with shallower penetration. DC (-) negative electrode results in a higher burn off rate and therefore a higher deposition rate at a given current. It is generally the chosen polarity for most GP Electrodes.

### AC MMA ELECTRODE Welding.

AC MMA (Stick) welding came about from old technology of AC transformer welding machines. Electrodes were manufactured to run on these AC machines. In fact, the electrodes made for AC welding will usually perform better on DC. AC is much louder and delivers a more violent arc which can cause inclusions and slag in the weld. Generally AC is more difficult to weld with than DC.

There can be a phenomenon called "arc-blow" with DC current where a magnetic field can build up and push the arc off to one side. If you are having issues with magnetism creating arc blow then the AC can help stabilise the arc and bring things back in line.

But for most other applications, AC is not needed. There are some Aluminium MMA electrodes available that do require AC current.

### ARC FORCE - What is the Arc Force Control and what does it do?

During welding arc voltage drops as the arc gets tighter and can cause the electrode to stick to the work piece. Arc force should be set according to the electrode diameter, electrode type, welding current and the technical requirement. When you set the arc force high the machine senses the drop in voltage, as the electrode is about to stick/short circuit to the work piece the machine responds by increasing the arc voltage and welding current momentarily (per millisecond). This boost in arc voltage/current blasts away base metal and electrode to prevent the electrode from sticking itself to the work piece. High arc force means the molten droplet from the melting electrode is larger with quicker transistion preventing the electrode from sticking, however too much arc force may create excessive spatter. Low arc force will result in a softer arc with minimal spatter and a nice shaped weld bead, however it may lead to the electrode sticking to the work piece easier, therefore the arc force should be adjusted to provide a smooth arc transistion between the electrode and workpiece without it sticking and without providing excessive spatter. Higher Arc Force is more suited to thicker electrodes under low amperage settings, out of position welding, low hydrogen type electrodes where a forceful arc characteristic is preferred to maintain the arc and better control penetration. Lower Arc Force is better suited to hardfacing and cast Iron electrodes where a soft buttery arc is preferred to prevent the electrode material diluting too much with the base metal.

One of the most common types of arc welding is manual metal arc welding (MMA) or stick welding. An electric current is used to strike an arc between the base material and a consumable electrode rod or 'stick'. The electrode rod is made of a material that is compatible with the base material being welded and is covered with a flux that gives off gaseous vapours that serve as a shielding gas and providing a layer of slag, both of which protect the weld area from atmospheric contamination. The electrode core itself acts as filler material the residue from the flux that forms a slag covering over the weld metal must be chipped away after welding.

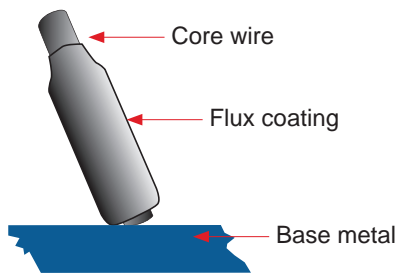
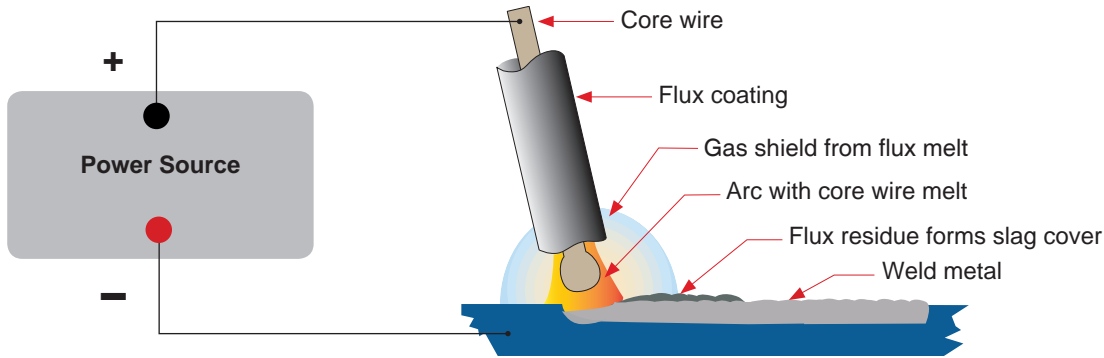

- The arc is initiated by momentarily touching the electrode to the base metal.
- The heat of the arc melts the surface of the base metal to form a molten pool at the end of the electrode.
- The melted electrode metal is transferred across the arc into the molten pool and becomes the deposited weld metal.
- The deposit is covered and protected by a slag which comes from the electrode coating.
- The arc and the immediate area are enveloped by an atmosphere of protective gas

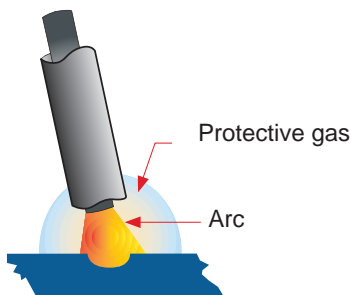

Manual metal arc (stick) electrodes have a solid metal wire core and a flux coating. These electrodes are identified by the wire diameter and by a series of letters and numbers. The letters and numbers identify the metal alloy and the intended use of the electrode.

The **Metal Wire Core** works as conductor of the current that maintains the arc. The core wire melts and is deposited into the welding pool.

The covering on a shielded metal arc welding electrode is called **Flux**. The flux on the electrode performs many different functions. These include:

- producing a protective gas around the weld area
- providing fluxing elements and deoxidizers
- creating a protective slag coating over the weld as it cools
- establishing arc characteristics
- adding alloying elements.

Covered electrodes serve many purposes in addition to adding filler metal to the molten pool. These additional functions are provided mainly by the covering on the electrode.

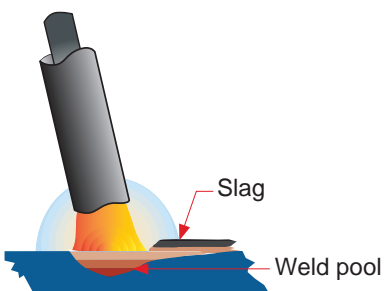



**Electrode Selection**

As a general rule, the selection of an electrode is straight forward, in that it is only a matter of selecting an electrode of similar composition to the parent metal. However, for some metals there is a choice of several electrodes, each of which has particular properties to suit specific classes of work. It is recommended to consult your welding supplier for the correct selection of electrode.

**Electrode Size**

Average Thickness of Material	Maximum Recommended Electrode Diameter
1.0 - 2.0mm	2.5mm
2.0 - 5.0mm	3.2mm
5.0 - 8.0mm	4.0mm
8.0 - > mm	5.0mm

The size of the electrode generally depends on the thickness of the section being welded, and the thicker the section the larger the electrode required. The table gives the maximum size of electrodes that maybe used for various thicknesses of section based on using a general purpose type 6013 electrode.

**Welding Current (Amperage)**

Electrode Size Ø mm	Current Range (Amps)
2.5mm	60 - 95
3.2mm	100 - 130
4.0mm	130 - 165
5.0mm	165 - 260

Correct current selection for a particular job is an important factor in arc welding. With the current set too low, difficulty is experienced in striking and maintaining a stable arc. The electrode tends to stick to the work, penetration is poor and beads with a distinct rounded profile will be deposited. Too high current is accompanied by overheating of the electrode resulting in undercut and burning through of the base metal and producing

excessive spatter. Normal current for a particular job may be considered as the maximum, which can be used without burning through the work, overheating the electrode or producing a rough spattered surface. The table shows current ranges generally recommended for a general purpose type 6013 electrode.

**Arc Length**

To strike the arc, the electrode should be gently scraped on the work until the arc is established. There is a simple rule for the proper arc length; it should be the shortest arc that gives a good surface to the weld. An arc too long reduces penetration, produces spatter and gives a rough surface finish to the weld. An excessively short arc will cause sticking of the electrode and result in poor quality welds. General rule of thumb for down hand welding is to have an arc length no greater than the diameter of the core wire.

**Electrode Angle**

The angle that the electrode makes with the work is important to ensure a smooth, even transfer of metal. When welding in down hand, fillet, horizontal or overhead the angle of the electrode is generally between 5 and 15 degrees towards the direction of travel. When vertical up welding the angle of the electrode should be between 80 and 90 degrees to the work piece.

**Travel Speed**

The electrode should be moved along in the direction of the joint being welded at a speed that will give the size of run required. At the same time, the electrode is fed downwards to keep the correct arc length at all times. Excessive travel speeds lead to poor fusion, lack of penetration etc, while too slow a rate of travel will frequently lead to arc instability, slag inclusions and poor mechanical properties.

**Material and Joint Preparation**

The material to be welded should be clean and free of any moisture, paint, oil, grease, mill scale, rust or any other material that will hinder the arc and contaminate the weld material. Joint preparation will depend on the method used include sawing, punching, shearing, machining, flame cutting and others. In all cases edges should be clean and free of any contaminants. The type of joint will be determined by the chosen application.

## DC HF TIG Welding Setup and Operation

1. Connect the Tig Torch connector to the negative terminal and tighten it.
  2. Insert the torch gas connector into the quick lock gas receptacle.
  3. Connect the torch switch remote lead into the torch remote socket.
  4. Connect the torch water leads connectors into the quick lock gas receptacles.
  5. Connect the Earth Cable connector into the positive terminal and tighten it.
  6. Turn on the Water Cooler with the on/off switch on the front panel of the Water Cooler.
  7. Connect gas line to Gas Regulator, connect the gas regulator to the Gas Cylinder, open the cylinder valve slowly.
  8. Connect the gas line to the quick lock gas inlet connector at the rear of the machine.
- Check for gas leaks - Esseti NZ Ltd nor it's representatives will be responsible for any gas loss.**
9. Switch on the machine using the On/Off switch at the rear of the machine.
  10. Set the weld parameters using the front panel set procedure on the following page.



## 9). Step by Step procedure for Basic HF DC TIG Welding - Front panel settings.

### 1. Select DC Tig Function.

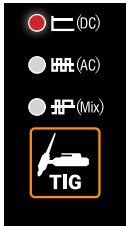

Select DC TIG by pressing the **TIG** button until the **DC** icon illuminates.

### 2. Select Torch Mode.

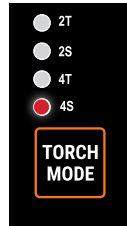

Select **2T** or **4T** trigger function as required by the pushing the **TORCH MODE** button to cycle through the trigger options. The icon will illuminate for the selected trigger option.

### 3. Select Arc Ignition



Select **HF** or **LIFT ARC** arc ignition required by the pushing the **HF- LIFT ARC** button to cycle through the options. The icon will illuminate for the selected arc ignition option.

### 4. Select DC Mode



Select **DC straight** welding mode (non pulse) by the pushing the **PULSE** button to select and illuminate the no pulse icon.

### 5. Select Tungsten Diameter

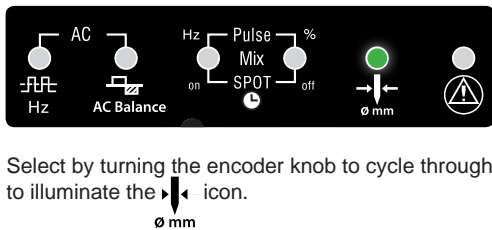

Select by turning the encoder knob to cycle through to illuminate the **2.4** icon.



Push the Encoder to lock the icon ready for adjustment.



Turn the Encoder to set the Tungsten diameter



The value selected shown on the digital display represents the % of time that the Peak Amp is on during the pulse cycle.

### 6. Select Pre Gas

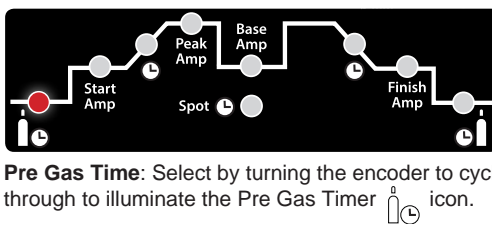

**Pre Gas Time:** Select by turning the encoder to cycle through to illuminate the Pre Gas Timer icon.



Push the Encoder to lock the icon ready for adjustment.



Turn the Encoder to set the Pre-Gas Time



The value selected shows on the digital display. It is the length of time the gas will flow before the arc starts.

### 7. Select Start Amps

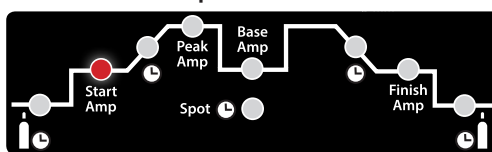

**Start Amp:** Select by pushing the encoder to cycle through to illuminate the Start Amp icon.



Push the Encoder to lock the icon ready for adjustment.



Turn the Encoder to set the Start Amp value



The value selected shows on the digital display. It is the amount of amps the machine will deliver at the start of the weld.

### 8. Select Up Slope Time

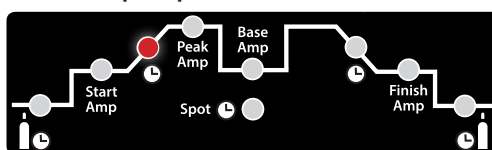

**Up Slope Time:** Select by turning the encoder to cycle through to illuminate the Up Slope icon.



Push the Encoder to lock the icon ready for adjustment.



Turn the Encoder to set the Up Slope value



The set value shows on the digital display. It is the time the welding current takes to rise from start amps to welding amperage.

9. Select Amperage

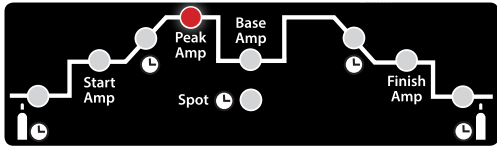

**Peak Amp:** Select by turning the encoder to cycle through to illuminate the Peak Amp icon.



Push the Encoder to lock the icon ready for adjustment.



Turn the Encoder to set the Peak Amp value



The setting shows on the digital display. It is the maximum amperage the machine will deliver during welding

10. Select Down Slope Time

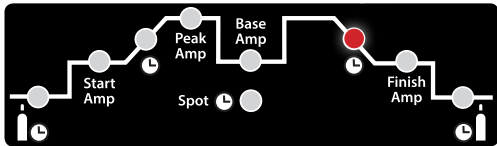

**Base Amp:** Select by turning the encoder to cycle through to illuminate the Down Slope icon.



Push the Encoder to lock the icon ready for adjustment.



Turn the Encoder to set the Down Slope time



The setting shows on the digital display. It is the time taken for the welding amps to drop down to the finish amperage.

11. Select Finish Amperage

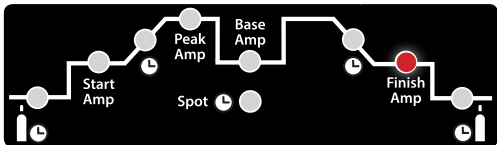

**Finish Amp:** Select by turning the encoder knob to cycle through to illuminate the Finish Amp icon.



Push the Encoder to lock the icon ready for adjustment.



Turn the Encoder to set the Finish Amp value



The setting shows on the digital display. It is the amperage the machine will deliver at the finish of the welding sequence.

12. Select Post Flow Gas Time

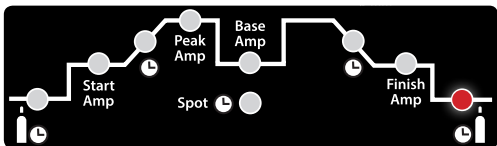

**Post Gas Time:** Select by turning the encoder knob to cycle through to illuminate the Post Gas Timer icon.



Push the Encoder to lock the icon ready for adjustment.



Turn the Encoder to set the Finish Amp value



Weld start procedure for HF AC, DC and MIX ARC TIG welding



1. Assemble the front end torch parts use the correct size and type of tungsten electrode for the job, the tungsten electrode requires a sharpened point for DC welding



4. Lay the outside edge of the Gas Cup on the work piece with the Tungsten Electrode 1- 3mm from the work piece



5. Press the torch switch and the arc will ignite across the gap between the tungsten and work piece. Hold even distance of about 2mm gap between the tungsten and work piece to maintain the arc.



6. Release the torch switch to bring in the end of the welding sequence dependant of 2T or 4T trigger function choice

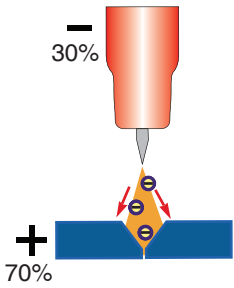

The DC power source uses what is known as DC (direct current) in which the main electrical component known as electrons flow in only one direction from the negative pole (terminal) to the positive pole (terminal). In the DC electrical circuit there is an electrical principle at work which should always be taken into account when using any DC circuit. With a DC circuit 70% of the energy (heat) is always on the positive side. This needs to be understood because it determines what terminal the TIG torch will be connected to (this rule applies to all the other forms of DC welding as well).

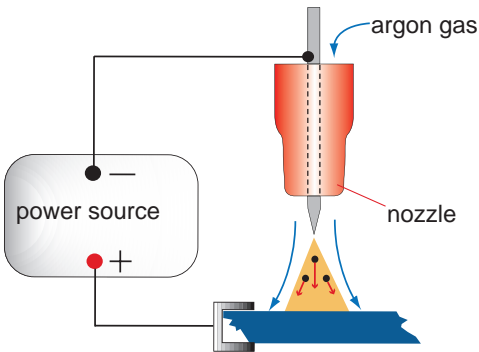

DC TIG welding is a process in which an arc is struck between a Tungsten electrode and the metal work piece. The weld area is shielded by an inert gas flow to prevent contamination of the tungsten, molten pool and weld area.

When the TIG arc is struck the inert gas is ionized and superheated changing its molecular structure which converts it into a plasma stream. This plasma stream flowing between the tungsten and the work piece is the TIG arc and can be as hot as 19,000°C. It is a very pure and concentrated arc which provides the controlled melting of most metals into a weld pool. TIG welding offers the user the greatest amount of flexibility to weld the widest range of material and thickness and types. DC TIG welding is also the cleanest weld with no sparks or spatter.

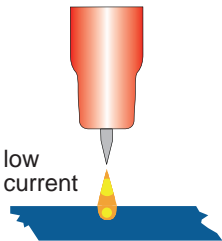

The intensity of the arc is proportional to the current that flows from the tungsten. The welder regulates the welding current to adjust the power of the arc. Typically thin material requires a less powerful arc with less heat to melt the material so less current (amps) is required, thicker material requires a more powerful arc with more heat so more current (amps) are necessary to melt the material.

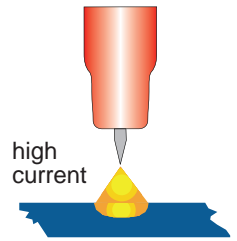

### HF ARC IGNITION for TIG (tungsten inert gas) Welding

HF (high frequency) ignition allows the arc to be started in TIG welding without touching the tungsten to the work piece. By pressing the torch switch the machine will activate the gas flow and introduce the HF (high frequency) (high voltage) spark, this "ionizes" the air gap making it conductive allowing an arc to be created without touching the tungsten to the work piece. The gas molecules are superheated by the arc creating a stream of super heated gas that changes the molecular structure into producing a plasma stream. This plasma stream provides heat and energy that allows us to melt and fuse metals in an inert gas shielded environment know as TIG (tungsten inert gas) welding.

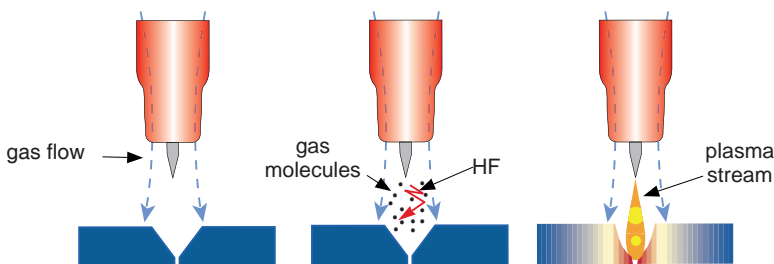

Pulse TIG welding is when the current output (amperage) changes between high and low current. Electronics within the welding machine create the pulse cycle. Welding is done during the high-amperage interval (this high amperage is referred to as peak current). During the low amperage period, the arc is maintained but the current output of the arc is reduced (this low amperage is referred to as base current). During pulse welding the weld pool cools during the low amperage period. This allows a lower overall heat input into the base metal. It allows for controlled heating and cooling periods during welding providing better control of heat input, weld penetration, operator control and weld appearance.

There are 4 variables within the pulse cycle:

#### Peak Current - Base Current - Pulse Frequency - Pulse Width

Setting and manipulation of these variables will determine the nature of the weld current output and is at the discretion of the operator.

**Peak Current** is the main welding current (amps) set to melt the material being welded and works much the same as setting maximum amperage values for regular DC TIG: as a guide use 30-40 amps for every 1mm of material thickness.

**Base Current** is the set level of background current (amps) which cools the weld puddle and effects overall heat input. As a rule, use enough background current to reduce the weld pool to about half its normal size while still keeping the weld pool fluid. As a guide start by setting the background amperage at 20 to 30 percent of peak amperage.

**Pulse Frequency** is the control of the amount of times per second (Hz) that the welding current switches from Peak Current to Base Current. DC Pulse TIG frequency generally ranges from 20 to 300 HZ depending on the job application. Control of the pulse frequency also determines the appearance of the weld.

**Pulse Width** is the control of the on time of the peak amp. It is the percentage of time the peak amp is on during one pulsing cycle. Example is with the Pulse Width set at 80 percent, the machine will spend 80% of the pulse at peak amperage and 20% at the base amperage. Increasing the pulse width percentage adds more heat to the job, while decreasing pulse width percentage reduces heat

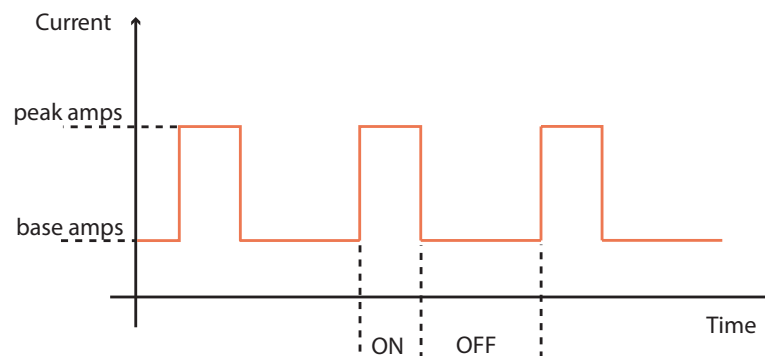

DC Pulse Tig welding allows faster welding speeds with better control of the heat input to the job, reducing the heat input minimising distortion and warping of the work and is of particular advantage in the welding of thin stainless steel and carbon steel applications. The high pulse frequency capability of the advanced inverter agitates the weld puddle and allows you to move quickly without transferring too much heat to the surrounding metal. Pulsing also constricts and focuses the arc thus increasing arc stability, penetration and travel speeds.

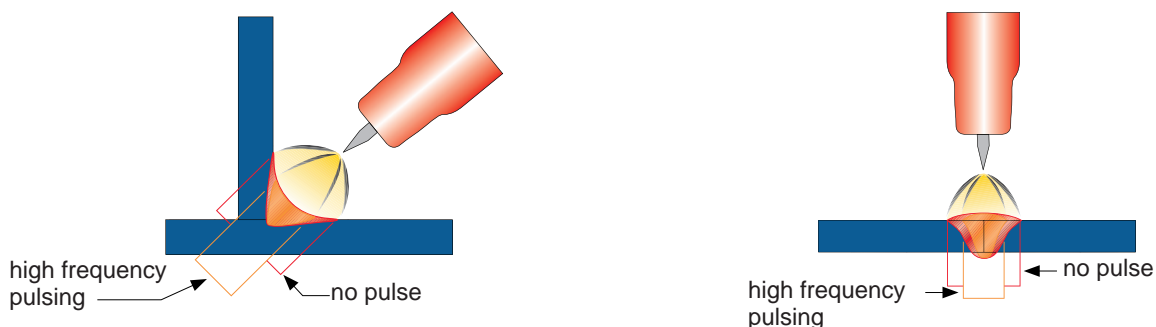

## DC Pulse Welding Set Up Procedure

### EXAMPLE OF PULSE DC TIG WELDING - SETUP PARAMETERS:

**Material = Stainless Steel x 2.0mm / Tungsten Electrode = 1.6mm 2% Thoriated / Gas = Argon**

The following steps are a guide as a starting point for you to set the machine up in Pulse mode to give an example of welding in Pulse mode function. You can experiment by changing any of the variables to see what effect it has over the welding and what the end result can be, but it is suggested to change only one variable at a time and then check the welding to see what the result is, in this way you acquire a better understanding of how each variable affects the welding current.

#### 1. Select DC Pulse Mode

Select **DC Pulse** welding mode by the pushing the **PULSE** button to select and illuminate the pulse icon.



#### Selecting Pulse Parameters

Select pulse parameters by turning the encoder to cycle through the front panel to select the pulse parameter icons and make settings as show in the following step by step procedure.

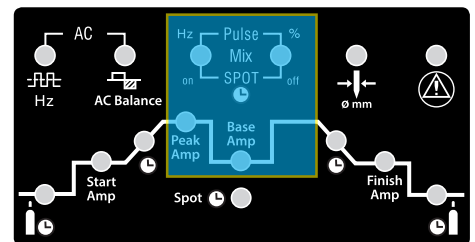

#### 2. Select Peak Amperage

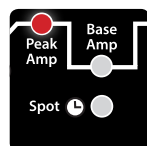

**Peak Amp:** Select by turning the encoder to cycle through to illuminate the **Peak Amp** icon.



Push the Encoder to lock the icon ready for adjustment.



Turn the Encoder to set Peak Amperage



The setting shows on the digital display.

#### 3. Select Base Amperage

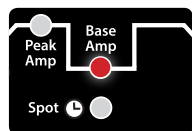

**Base Amp:** Turn the encoder to cycle through to illuminate the **Base Amp** icon.



Push the Encoder to lock the icon ready for adjustment.

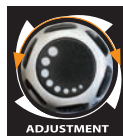

Turn the Encoder to set Base Amperage



The setting shows on the digital display.

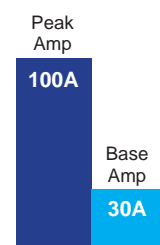

#### 4. Select Pulse Frequency Hz

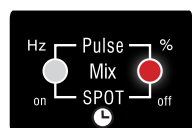

**Base Amp:** Turn the encoder to cycle through to illuminate the **Base Amp** icon.



Push the Encoder to lock the icon ready for adjustment.



Turn the Encoder to set the Base Amperage



The value selected is the number of times the current switches from Peak Amp to Base Amp per second

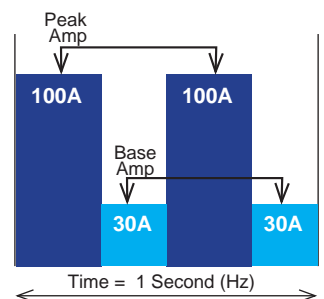

#### 5. Select Pulse Width

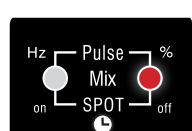

**Pulse %:** Turn the encoder to cycle through to illuminate the **Pulse %** icon.



Push the Encoder to lock the icon ready for adjustment.



Turn the Encoder to set the Base Amperage



The value selected is the % of time the Peak Amp is on during each pulse cycle.

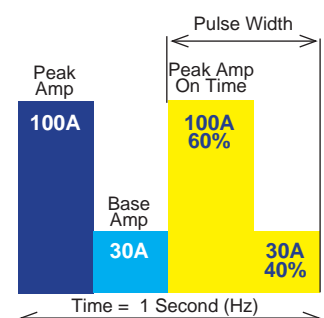

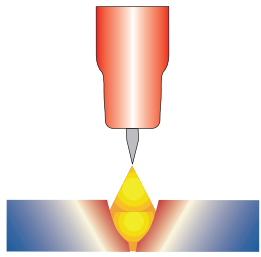

Manual TIG welding is often considered the most difficult of all the welding processes. Because the welder must maintain a short arc length, great care and skill are required to prevent contact between the electrode and the workpiece. Similar to Oxygen Acetylene torch welding, TIG welding normally requires two hands and in most instances requires the welder to manually feed a filler wire into the weld pool with one hand while manipulating the welding torch in the other. However, some welds combining thin materials can be accomplished without filler metal like edge, corner, and butt joints.

This is known as Fusion welding where the edges of the metal pieces are melted together using only the heat and arc force generated by the TIG arc. Once the arc is started the torch tungsten is held in place until a weld pool is created, a circular movement of the tungsten will assist in creating a weld pool of the desired size. Once the weld pool is established tilt the torch at about a 75° angle and move smoothly and evenly along the joint while fusing the materials together.

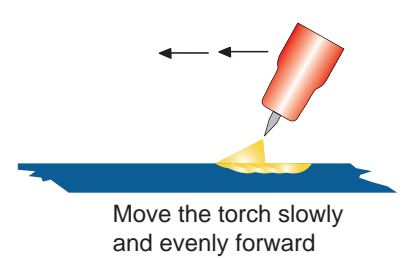
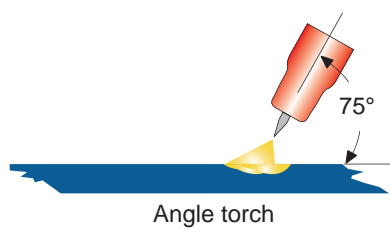
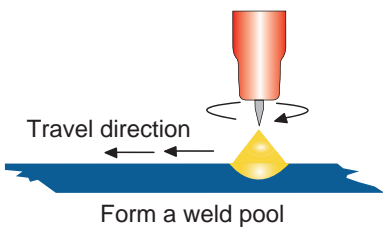

### TIG Welding with Filler Wire Technique

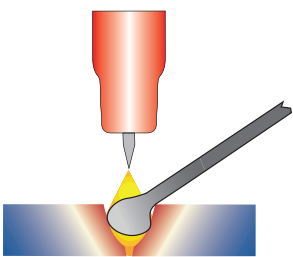

It is necessary in many situations with TIG welding to add a filler wire into the weld pool to build up weld reinforcement and create a strong weld. Once the arc is started the torch tungsten is held in place until a weld pool is created, a circular movement of the tungsten will assist in creating a weld pool of the desired size. Once the weld pool is established tilt the torch at about a 75° angle and move smoothly and evenly along the joint. The filler metal is introduced to the leading edge of the weld pool. The filler wire is usually held at about a 15° angle and fed into the leading edge of the molten pool, the arc will melt the filler wire into the weld pool as the torch is moved forward.

Also a dabbing technique can be used to control the amount of filler wire added, the wire is fed into the molten pool and retracted in a repeating sequence as the torch is moved slowly and evenly forward. It is important during the welding to keep the molten end of the filler wire inside the gas shield as this protects the end of the wire from being oxidised and contaminating the weld pool.

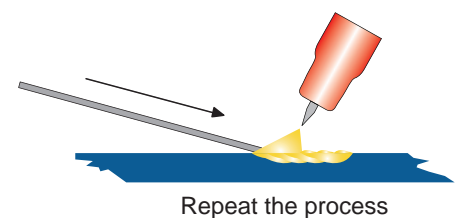
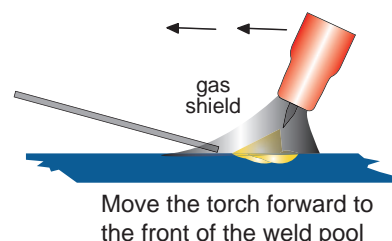
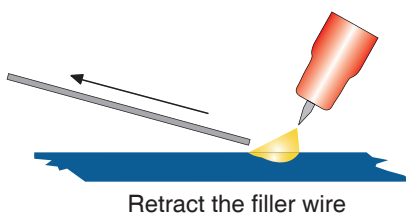
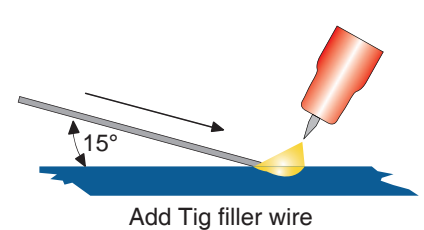
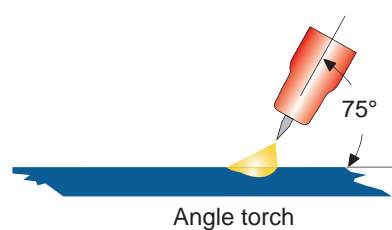
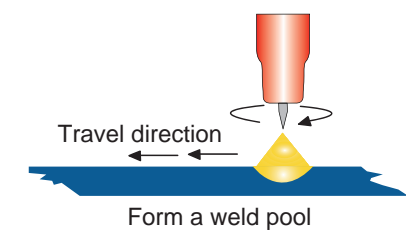



## AC and MIX ARC TIG Welding Setup and Operation

1. Connect the Tig Torch connector to the negative terminal and tighten it.
  2. Insert the torch gas connector into the quick lock gas receptacle.
  3. Connect the torch switch remote lead into the torch remote socket.
  4. Connect the torch water leads connectors into the quick lock gas receptacles.
  5. Connect the Earth Cable connector into the positive terminal and tighten it.
  6. Turn on the Water Cooler with the on/off switch on the front panel of the Water Cooler.
  7. Connect gas line to Gas Regulator, connect the gas regulator to the Gas Cylinder, open the cylinder valve slowly.
  8. Connect the gas line to the quick lock gas inlet connector at the rear of the machine.
- Check for gas leaks - Esseti NZ Ltd nor it's representatives will be responsible for any gas loss.**
9. Switch on the machine using the On/Off switch at the rear of the machine.
  10. Set the weld parameters using the front panel set procedure on the following page.



### 9). Step by Step procedure for Basic HF AC TIG Welding - Front panel settings.

#### 1. Select AC Tig Function.



Select AC TIG by pressing the **TIG** button until the **AC** icon illuminates.

#### 4. Select AC WAVE

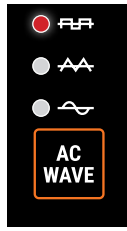

Select your choice of AC wave form by the pushing the **AC WAVE** button to select and illuminate the icon of your choice. (see page for detailed AC Wave form information)

#### 2. Select Torch Mode.

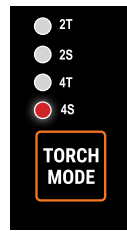

Select **2T** or **4T** trigger function as required by the pushing the **TORCH MODE** button to cycle through the trigger options. The icon will illuminate for the selected trigger option.

#### 3. Select Arc Ignition



Select **HF** or **LIFT ARC** arc ignition required by the pushing the **HF- LIFT ARC** button to cycle through the options. The icon will illuminate for the selected arc ignition option.

#### 4. Select AC Frequency (Hz)

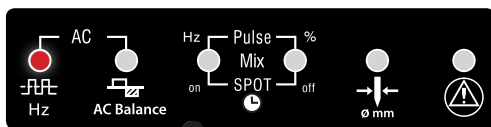

Select by turning the encoder knob to cycle through to illuminate the AC Hz icon. (see page for detailed AC Hz information)



Push the Encoder to lock the icon ready for adjustment.



Turn the Encoder to set the Tungsten diameter



The value selected shown on the digital display represents the % of time that the Peak Amp is on during the pulse cycle.

#### 5. Select AC Balance

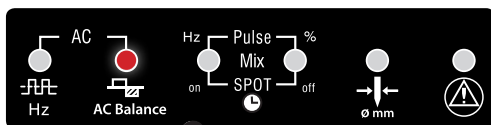

Select by turning the encoder knob to cycle through to illuminate the AC Balance icon. (see page for detailed AC Balance information)



Push the Encoder to lock the icon ready for adjustment.



Turn the Encoder to set the Tungsten diameter



The value selected shown on the digital display represents the % of time that the Peak Amp is on during the pulse cycle.

#### 6. Select Tungsten Diameter

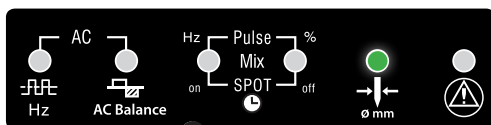

Select by turning the encoder knob to cycle through to illuminate the icon.



Push the Encoder to lock the icon ready for adjustment.



Turn the Encoder to set the Tungsten diameter



The value selected shown on the digital display represents the % of time that the Peak Amp is on during the pulse cycle.

#### 7. Select Pre Gas

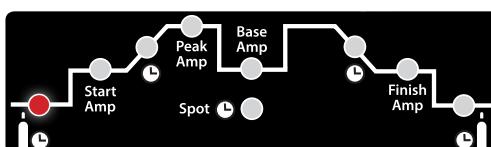

**Pre Gas Time:** Select by turning the encoder to cycle through to illuminate the Pre Gas Timer icon.



Push the Encoder to lock the icon ready for adjustment.



Turn the Encoder to set the Pre-Gas Time



The value selected shows on the digital display. It is the length of time the gas will flow before the arc starts.

8. Select Start Amps

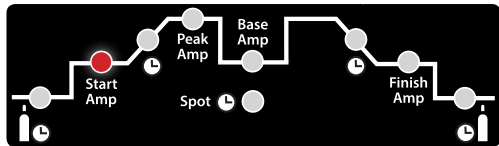

**Start Amp:** Select by pushing the encoder to cycle through to illuminate the Start Amp icon.



Push the Encoder to lock the icon ready for adjustment.

Turn the Encoder to set the Start Amp value

The value selected shows on the digital display. It is the amount of amps the machine will deliver at the start of the weld.

9. Select Up Slope Time

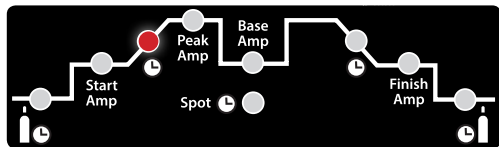

**Up Slope Time:** Select by turning the encoder to cycle through to illuminate the Up Slope icon.



Push the Encoder to lock the icon ready for adjustment.

Turn the Encoder to set the Up Slope value

The set value shows on the digital display. It is the time the welding current takes to rise from start amps to welding amperage.

9. Select Amperage

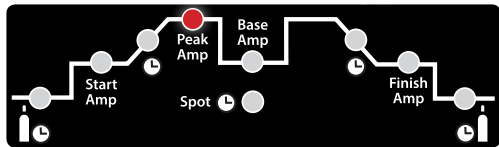

**Peak Amp:** Select by turning the encoder to cycle through to illuminate the Peak Amp icon.



Push the Encoder to lock the icon ready for adjustment.

Turn the Encoder to set the Peak Amp value

The setting shows on the digital display. It is the maximum amperage the machine will deliver during welding

10. Select Down Slope Time

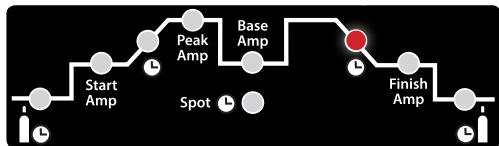

**Base Amp:** Select by turning the encoder to cycle through to illuminate the Down Slope icon.



Push the Encoder to lock the icon ready for adjustment.

Turn the Encoder to set the Down Slope time

The setting shows on the digital display. It is the time taken for the welding amps to drop down to the finish amperage.

11. Select Finish Amperage

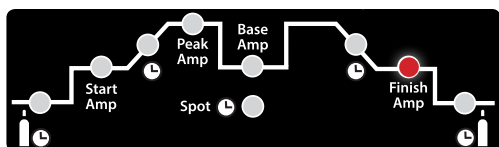

**Finish Amp:** Select by turning the encoder knob to cycle through to illuminate the Finish Amp icon.



Push the Encoder to lock the icon ready for adjustment.

Turn the Encoder to set the Finish Amp value

The setting shows on the digital display. It is the amperage the machine will deliver at the finish of the welding sequence.

12. Select Post Flow Gas Time

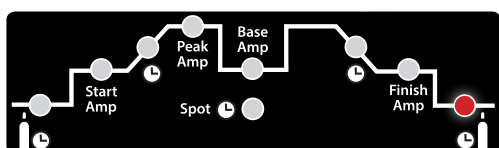

**Post Gas Time:** Select by turning the encoder knob to cycle through to illuminate the Post Gas icon.



Push the Encoder to lock the icon ready for adjustment.

Turn the Encoder to set the Finish Amp value

## AC WAVE FORMS

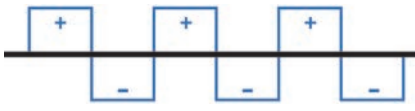

**AC Square Wave:** Allows the current to change from electrode + positive to electrode - negative very quickly. This produces high voltage as the current switches polarities allowing the arc to re-start easily. The arc can be maintained without the use of high-frequency and the fast transitions provide for responsive, dynamic and focused arc for better directional control.

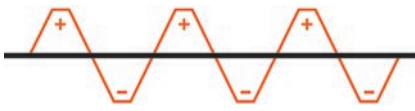

**AC Triangle Wave:** Characterised by a particularly soft and concentrated arc combining the effect of peak amperage while reducing overall heat input. Leads to quick puddle formation and, because of lowered heat input, reduced weld distortion, especially on thin material. This wave form is ideal for very precise welding of thin Aluminum plate.

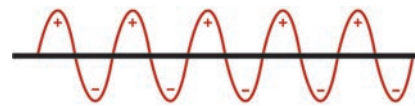

**AC Sine Wave:** It is the standard Wave form, characterised by low noise and excellent arc control, it also gives the soft-arc feel of a conventional power source, while using square transitions to eliminate the need for continuous HF.

## AC WAVE FORM FREQUENCY CONTROL

It is possible with the RAZOR320ACDC machine to adjust the frequency of the AC Square Wave output. It means that the amount of time that it takes the AC square wave to complete a full cycle switch from positive (+) to negative (-) can be adjusted from 20Hz (20 times per second) to 200Hz.

Increasing frequency (Hz) causes the current to change direction more often, which means that it spends less time per cycle in both DC electrode negative and DC electrode positive mode. By spending less time at each polarity, the arc cone has less time to expand.

A higher frequency produces a narrower arc cone producing an arc that is tighter with more focus at the exact spot the electrode is pointing. The result is improved arc stability, ideal for fillet welds and other fit ups requiring precise penetration. Decreasing the frequency softens the arc and broadens the weld pool producing a wider bead, produces good overall penetration and ideal for build up applications.

AC Square Wave Hz

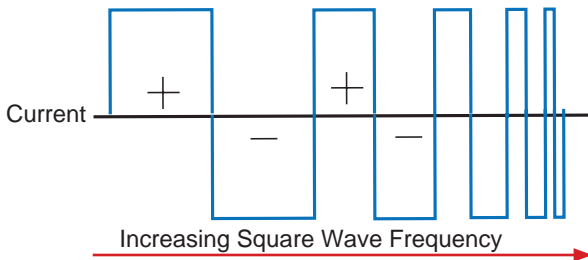

Slower AC Square Wave Hz

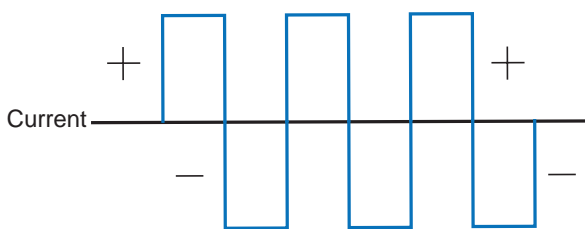

Slower AC Square Wave Hz

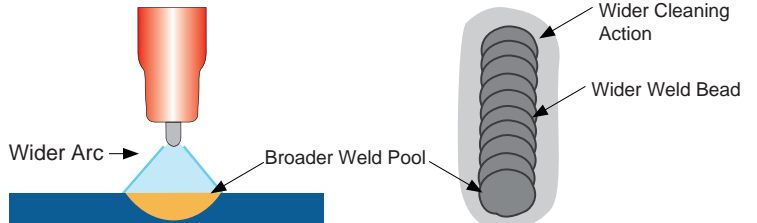

Faster AC Square Wave Hz

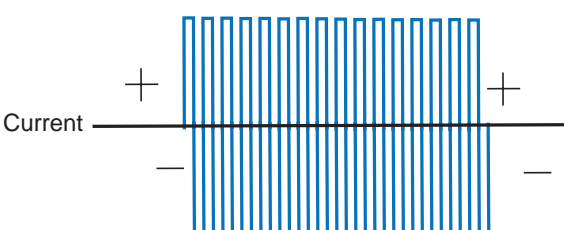

Faster AC Square Wave Hz

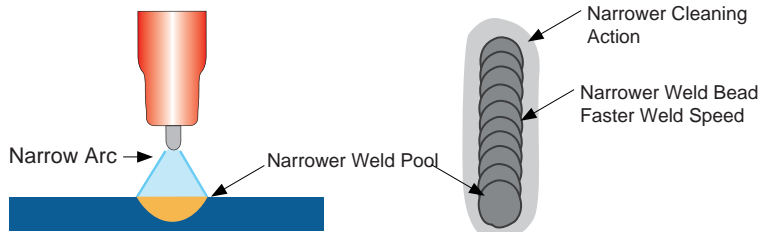

AC (alternating current) enables us to TIG weld non ferrous alloys like Aluminium, Magnesium and Aluminium Alloys. These materials have an insulating surface oxide layer that melts at a higher temperature than the base metal making it difficult to weld the base metal if the oxides are not removed. AC welding current is ideal because the nature of the AC wave form assists in breaking the surface oxide layer.

AC (alternating current) has a current cycle that flows from + (direct) polarity to - (reverse) polarity.

The reversing of the polarity breaks the surface oxide while the direct polarity melts the base material.

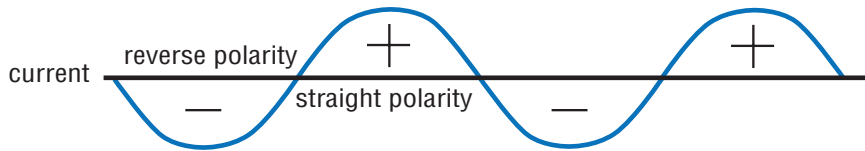

There are inherent problems that come with AC TIG arc rectification, arc stutter, arc wandering and arc stoppage. These problems typically occur during the transition between + and - cycles.

The current is lesser (30%) during the half of the cycle when the electrode is positive and there is a resistance of the electron flow during this half cycle (rectification). The lack of current flow during this half cycle makes the AC arc unstable.

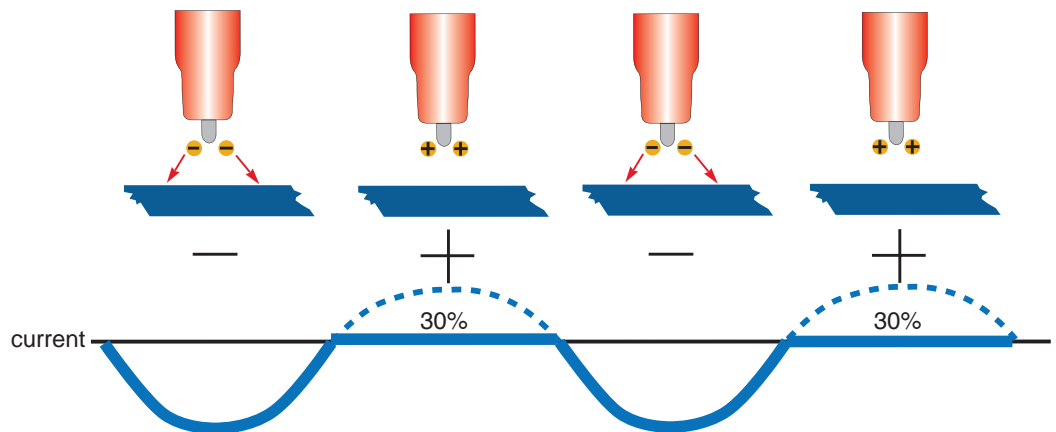

To overcome this lack of flow during one half of the cycle, a high-frequency (HF) voltage is generated and fed into the welding circuit. The HF maintains the arc stability during the half cycle when the electrode is positive.

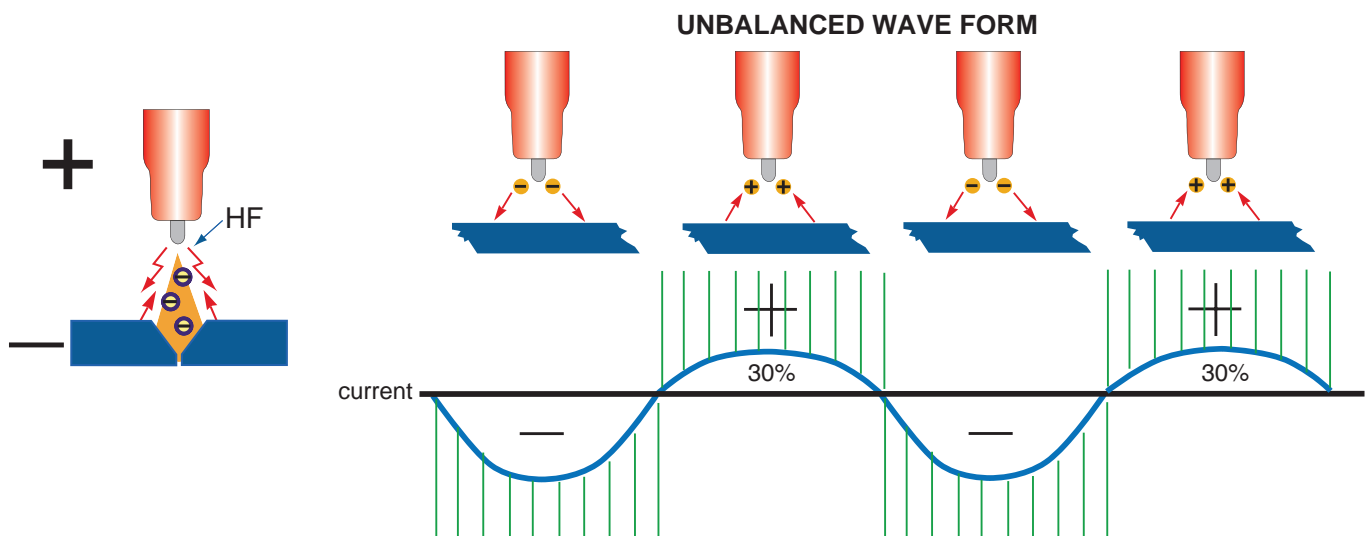

High-frequency voltage flows continually in the welding circuit and keeps the shielding arc in the welding area in an ionized state. When the arc is ionized the arc is maintained during the half of the cycle when the electrode is positive. However while the arc is maintained less current flows during this half of the AC cycle, producing an unbalanced wave.

In older machines, a balanced current output wave was achieved using a large number of capacitors in series or a battery in the welding circuit. Modern TIG power sources use electronics to create and maintain a balanced wave and now most AC TIG power sources produce a square wave current output.

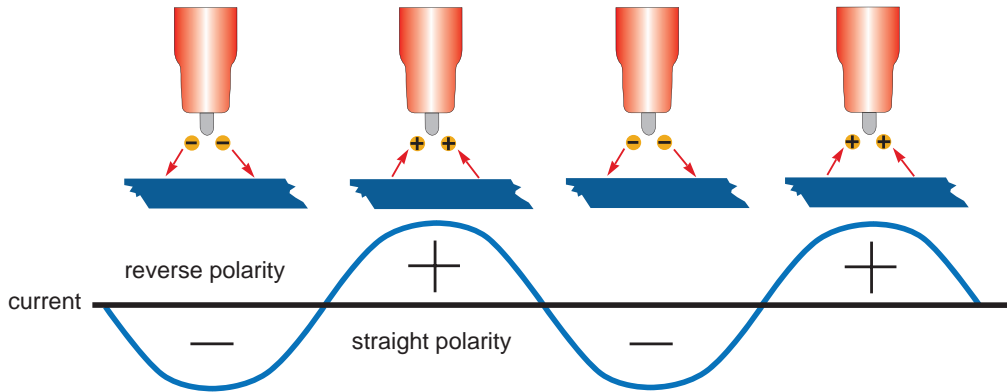

A square wave power supply can change the current from electrode + positive to electrode - negative very quickly. This produces high voltage as the current switches polarities allowing the arc to restart easily. The arc can be maintained without the use of high-frequency or any other arc stabilising methods.

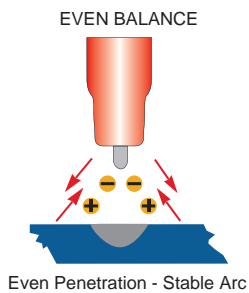

**BALANCED SQUARE WAVE FORM**

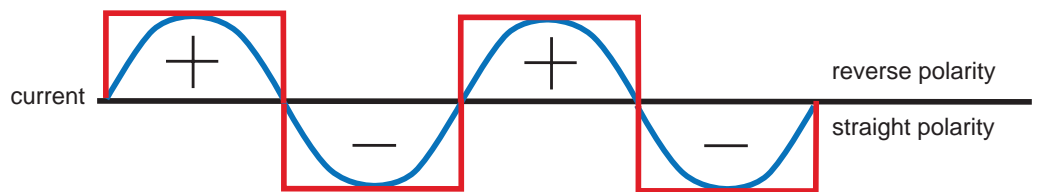

The output current and voltage are controlled electronically so the balance between the amount of current electrode positive and the amount of current electrode negative can be adjusted. This allows the welder to adjust the amount of cleaning and the amount of penetration. This is achieved electronically by adjusting the balance control dial on the welding machine. More current flow from the + polarity produces stronger arc energy and current flow from the tungsten and is good for removing the oxidized surface of the work piece. However too much + current flow can drive too much energy to the tungsten causing it to overheat and melt the tungsten electrode.

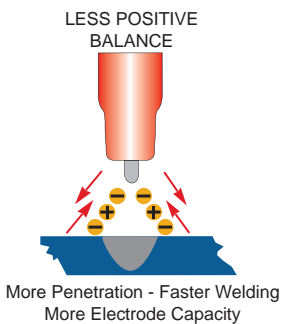

**Balance Adjusted for More Penetration - Cooler Tungsten**

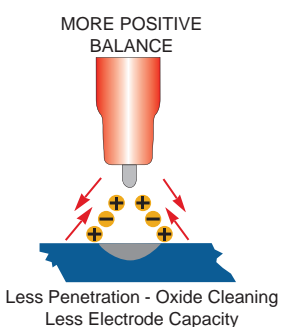
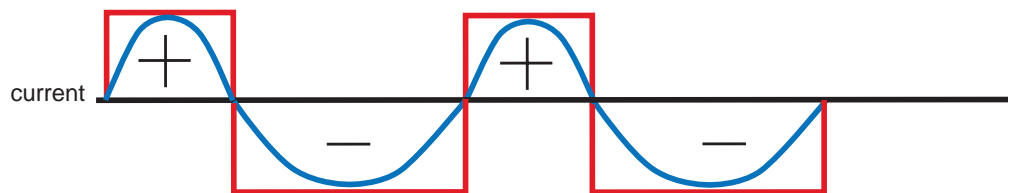

**Balance Adjusted for More Oxide Cleansing Action - Hotter Tungsten**

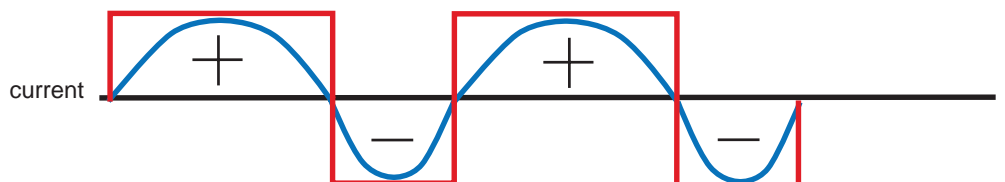

## AC Pulse Welding Set Up Procedure

### EXAMPLE OF PULSE AC TIG WELDING - SETUP PARAMETERS:

**Material = Aluminium x 3.0mm / Tungsten Electrode = 2.4mm Zirconiated / Gas = Argon**

The following steps are a guide as a starting point for you to set the machine up in Pulse mode to give an example of welding in Pulse mode function. You can experiment by changing any of the variables to see what effect it has over the welding and what the end result can be, but it is suggested to change only one variable at a time and then check the welding to see what the result is, in this way you acquire a better understanding of how each variable affects the welding current.

#### 1. Select Pulse Mode



Select **Pulse** welding mode by pushing the **PULSE** button to select and illuminate the pulse icon.

#### Selecting Pulse Parameters

Select pulse parameters by turning the encoder to cycle through the front panel to select the pulse parameter icons and make settings as show in the following step by step procedure.

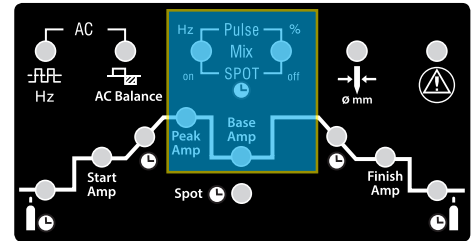

#### 2. Select Peak Amperage

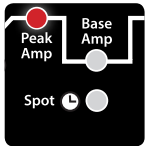

**Peak Amp:** Select by turning the encoder to cycle through to illuminate the **Peak Amp** icon.



Push the Encoder to lock the icon ready for adjustment.



Turn the Encoder to set the Peak Amperage



The setting shows on the digital display.

#### 3. Select Base Amperage

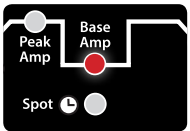

**Base Amp:** Turn the encoder to cycle through to illuminate the **Base Amp** icon.



Push the Encoder to lock the icon ready for adjustment.

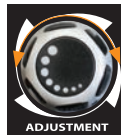

Turn the Encoder to set the Base Amperage



The setting shows on the digital display.

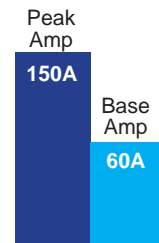

#### 4. Select Pulse Frequency Hz

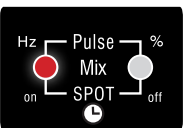

**Pulse Hz:** Turn the encoder to cycle through to illuminate the **Hz** icon.



Push the Encoder to lock the icon ready for adjustment.



Turn the Encoder to set the Base Amperage



The value selected is the number of times the current switches from Peak Amp to Base Amp per second

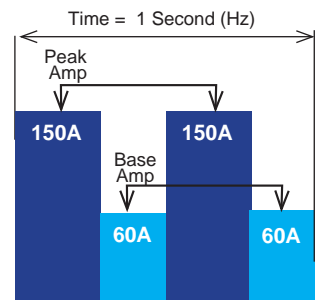

#### 5. Select Pulse Width

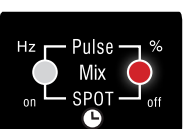

**Pulse %:** Turn the encoder to cycle through to illuminate the **Pulse %** icon.



Push the Encoder to lock the icon ready for adjustment.



Turn the Encoder to set the Base Amperage



The value selected is the % of time the Peak Amp is on during each pulse cycle.

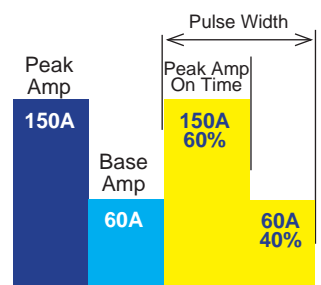

## MIX ARC WELDING

MIX Arc is an innovative welding solution for high current AC welding applications. This function of MIX AC/DC makes it possible to modulate the welding current, alternating a period of TIG AC with a period of TIG DC-. This means that the efficiency of AC TIG welding can be combined with the high penetration of DC TIG welding, obtaining higher welding speeds, establishing the weld puddle quicker on cold workpieces, increase weld penetration and reduces tungsten tip temperature. Other benefits are the welding of extremely diverse material thickness eg., 1mm to 10mm and helping bridge and close gaps between two joints during welding.

The result in welding is similar to AC PULSE welding but with a stronger arc force in the molten pool making it particularly suitable for welding thicker material.

During the AC period of the arc the oxide film is broken, the welding arc becomes wider and the surface impurities are flushed out. During the DC period of the arc the arc becomes narrower, the molten pool is drawn deeper into the workpiece improving penetration.

The operator adjustable parameter is the percentage of AC waveform compared to DC- waveform, which can be varied from 5~95%. It is good practice never to exceed the value of 50% DC - waveform, which would otherwise impair the oxide removal and flushing portion of the weld and effect the appearance of the weld bead.

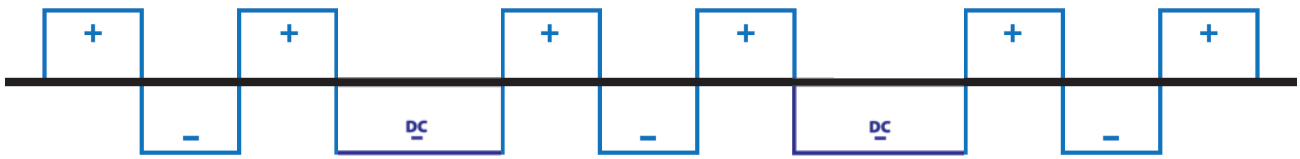

MIX ARC can be used with the different AC wave forms of Square Wave, Triangle Wave and Sinusoidal Wave.

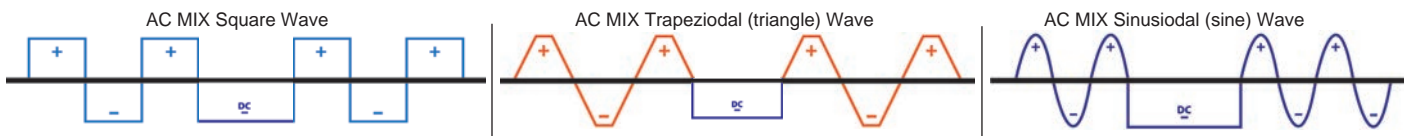

## SET UP PROCEDURE FOR MIX ARC WELDING

1. Follow the step by step procedure for AC TIG Welding shown on pages 32-33



2. Select MIX ARC by pressing the TIG button until the MIX icon illuminates.

3. Select MIX HZ (Adjusts the frequency Hz (times per second) that the output current switches from AC to DC-)

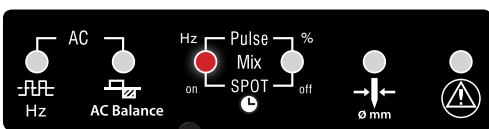

MIX HZ: Select by turning the encoder knob to cycle through to illuminate the Hz icon.



Push the Encoder to lock the icon ready for adjustment.



Turn the Encoder to set the MIX ARC Frequency Range is (1-10 Hz)



The value selected is the number of times per second that the output welding current switches from AC to DC-

4. Select MIX % Adjusts the period of DC- output during MIX ARC welding.

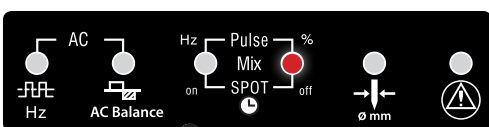

MIX %: Select by turning the encoder knob to cycle through to illuminate the % icon.



Push the Encoder to lock the icon ready for adjustment.



Turn the Encoder to set the MIX ARC % value Range is (5-95%)



The value selected is the % of DC- output during MIX ARC welding.



Remote amperage controls allow remote welding current adjustment from the welding machine during welding.

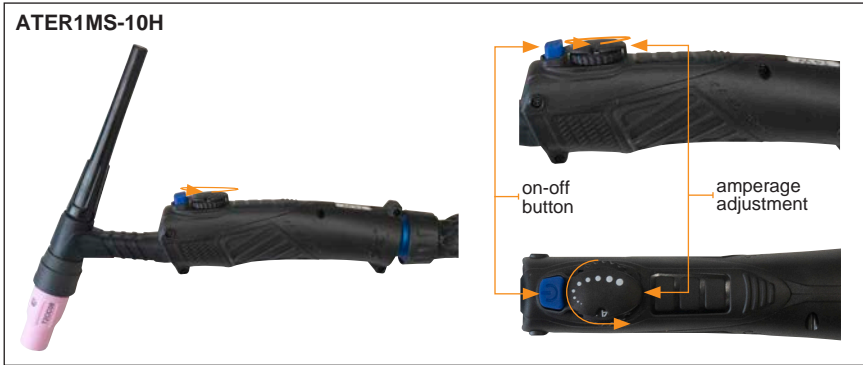

## Connection and operation of the remote hand control

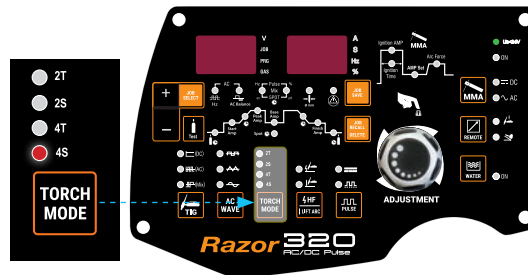

1. Connect the remote control 7 pin plug from the Tig Torch switch lead to the 7 pin remote receptacle on the front panel of the machine.

2. Select 4T or 4S trigger function as required by the pushing the **TORCH MODE** button to cycle through the trigger options. The icon will illuminate for the selected trigger option.

**Note:** remote hand amp control requires 4T or 4S trigger option, it wont work with 2T or 2S

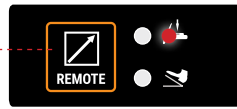
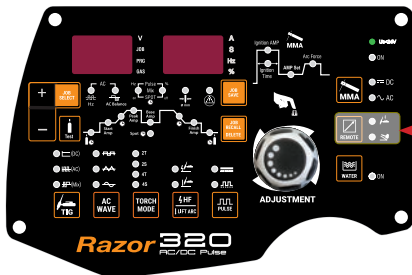

3. Select torch mounted remote control by pushing the Remote button to illuminate the  icon.



4. Rotate the dial to adjust the amperage output of the machine. The remote can be used static or during welding to adjust the amps up or down.

5. The amps set by the remote control will show in the display on the front panel.

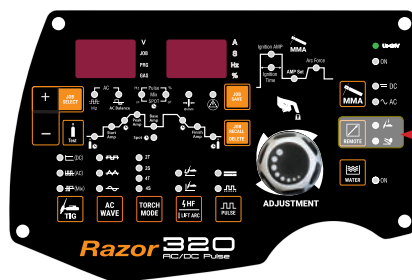
## Connection and operation of the remote foot control



1. Connect the remote control 7 pin plug from the Tig Torch switch lead to the 7 pin remote receptacle on the front panel of the machine.

3. Select torch mounted remote control by pushing the Remote  button to illuminate the  icon.

3. Up & down travel of the foot pedal will adjust the welding amperage during welding. The side potentiometer knob will allow manual set and adjustment.

## Tungsten Electrodes

Tungsten is a rare metallic element used for manufacturing TIG welding electrodes. The TIG process relies on tungsten's hardness and high-temperature resistance to carry the welding current to the arc. Tungsten has the highest melting point of any metal, 3,410 degrees Celsius. Tungsten electrodes are nonconsumable and come in a variety of sizes, they are made from pure tungsten or an alloy of tungsten and other rare earth elements. Choosing the correct tungsten depends on the material being welded, amps required and whether you are using AC or DC welding current. Tungsten electrodes are colour-coded at the end for easy identification. Below are the most commonly used tungsten electrodes found in the New Zealand and Australian market.

### Thoriated

Thoriated tungsten electrodes (AWS classification EWTh-2) contain a minimum of 97.30 percent tungsten and 1.70 to 2.20 percent thorium and are called 2 percent thoriated. They are the most commonly used electrodes today and are preferred for their longevity and ease of use. Thorium however is a low-level radioactive hazard and many users have switched to other alternatives. Regarding the radioactivity, thorium is an alpha emitter but when it is enclosed in a tungsten matrix the risks are negligible. Thoriated tungsten should not get in contact with open cuts or wounds. The more significant danger to welders can occur when thorium oxide gets into the lungs. This can happen from the exposure to vapours during welding or from ingestion of material/dust in the grinding of the tungsten. Follow the manufacturer's warnings, instructions, and the Material Safety Data Sheet (MSDS) for its use.

### E3 (Color Code: Lilac)

E3 tungsten electrodes (AWS classification EWG) contain a minimum of 98% percent tungsten and up to 1.5 percent Lanthanum and small percentages of Zirconium and Yttrium they are called E3 Tungsten. E3 Tungsten Electrodes provide conductivity similar to that of thoriated electrodes. Typically, this means that E3 Tungsten Electrodes are exchangeable with thoriated electrodes without requiring significant welding process changes. E3 deliver superior arc starting, electrode lifetime, and overall cost-effectiveness. When E3 Tungsten Electrodes are compared with 2% thoriated tungsten, E3 requires fewer re-grinds and provides a longer overall lifetime. Tests have shown that ignition delay with E3 Tungsten Electrodes actually improves over time, while 2% thoriated tungsten starts to deteriorate after only 25 starts. At equivalent energy output, E3 Tungsten Electrodes run cooler than 2% thoriated tungsten, thereby extending overall tip lifetime. E3 Tungsten Electrodes work well on AC or DC. They can be used DC electrode positive or negative with a pointed end, or balled for use with AC power sources.

### Ceriated (Color Code: Orange)

Ceriated tungsten electrodes (AWS classification EWCe-2) contain a minimum of 97.30 percent tungsten and 1.80 to 2.20 percent cerium and are referred to as 2 percent ceriated. Ceriated tungstens perform best in DC welding at low current settings. They have excellent arc starts at low amperages and become popular in such applications as orbital tube welding, thin sheet metal work. They are best used to weld carbon steel, stainless steel, nickel alloys, and titanium, and in some cases it can replace 2 percent thoriated electrodes. Ceriated tungsten is best suited for lower amperages it should last longer than Thoriated tungsten higher amperage applications are best left to Thoriated or Lanthanated tungsten.

### Lanthanated (Color Code: Gold)

Lanthanated tungsten electrodes (AWS classification EWL-1.5) contain a minimum of 97.80 percent tungsten and 1.30 percent to 1.70 percent lanthanum, and are known as 1.5 percent lanthanated. These electrodes have excellent arc starting, a low burn off rate, good arc stability, and excellent re-ignition characteristics. Lanthanated tungstens also share the conductivity characteristics of 2 percent thoriated tungsten. Lanthanated tungsten electrodes are ideal if you want to optimise your welding capabilities. They work well on AC or DC electrode negative with a pointed end, or they can be balled for use with AC sine wave power sources. Lanthanated tungsten maintains a sharpened point well, which is an advantage for welding steel and stainless steel on DC or AC from square wave power sources.

### Zirconiated (Color Code: White)

Zirconiated tungsten electrodes (AWS classification EWZr-1) contain a minimum of 99.10 percent tungsten and 0.15 to 0.40 percent zirconium. Most commonly used for AC welding Zirconiated tungsten produces a very stable arc and is resistant to tungsten spitting. It is ideal for AC welding because it retains a balled tip and has a high resistance to contamination. Its current-carrying capacity is equal to or greater than that of thoriated tungsten. Zirconiated tungsten is not recommended for DC welding.

## Tungsten Electrodes Rating for Welding Currents

Tungsten Diameter mm	DC Current Amps Torch Negative 2% Thoriated	AC Current Amps Un-Balanced Wave 0.8% Zirconiated	AC Current Amps Balanced Wave 0.8% Zirconiated
1.0mm	15 - 80	15 - 80	20 - 60
1.6mm	70 - 150	70 - 150	60 - 120
2.4mm	150 - 250	140 - 235	100 - 180
3.2mm	250 - 400	225 - 325	160 - 250
4.0mm	400 - 500	300 - 400	200 - 320

## Tungsten Preparation

Always use **DIAMOND** wheels when grinding and cutting. While tungsten is a very hard material, the surface of a diamond wheel is harder, and this makes for smooth grinding. Grinding without diamond wheels, such as aluminium oxide wheels, can lead to jagged edges, imperfections, or poor surface finishes not visible to the eye that will contribute to weld inconsistency and weld defects.

Always ensure to grind the tungsten in a longitudinal direction on the grinding wheel. Tungsten electrodes are manufactured with the molecular structure of the grain running lengthwise and thus grinding crosswise is "grinding against the grain." If electrodes are ground crosswise, the electrons have to jump across the grinding marks and the arc can start before the tip and wander. Grinding longitudinally with the grain, the electrons flow steadily and easily to the end of the tungsten tip. The arc starts straight and remains narrow, concentrated, and stable.

grind longitudinal on the grinding wheel

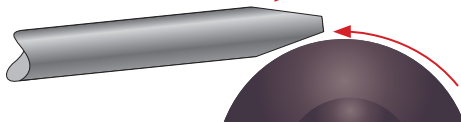

don't grind across the grinding wheel

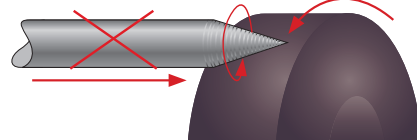

### Electrode Tip/Flat

The shape of the tungsten electrode tip is an important process variable in precision arc welding. A good selection of tip/flat size will balance the need for several advantages. The bigger the flat, the more likely arc wander will occur and the more difficult it will be to arc start. However, increasing the flat to the maximum level that still allows arc start and eliminates arc wander will improve the weld penetration and increase the electrode life. Some welders still grind electrodes to a sharp point, which makes arc starting easier. However, they risk decreased welding performance from melting at the tip and the possibility of the point falling off into the weld pool.

2.5 times tungsten diameter

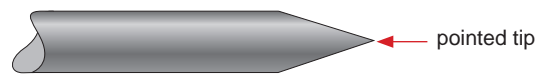
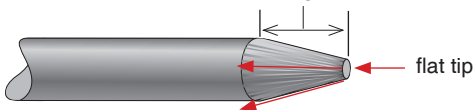

### Electrode Included Angle/Taper - DC Welding

Tungsten electrodes for DC welding should be ground longitudinally and concentrically with diamond wheels to a specific included angle in conjunction with the tip/flat preparation. Different angles produce different arc shapes and offer different weld penetration capabilities. In general, blunter electrodes that have a larger included angle provide the following benefits:

- Last Longer
- Have better weld penetration
- Have a narrower arc shape
- Can handle more amperage without eroding.

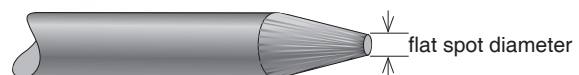

Sharper electrodes with smaller included angle provide:

- Offer less arc weld
- Have a wider arc
- Have a more consistent arc



The included angle determines weld bead shape and size. Generally, as the included angle increases, penetration increases and bead width decreases.

Tungsten Diameter	Diameter at the Tip - mm	Constant Included Angle - Degrees	Current Range Amps	Current Range Pulsed Amps
1.0mm	.250	20	05 - 30	05 - 60
1.6mm	.500	25	08 - 50	05 - 100
1.6mm	.800	30	10 - 70	10 - 140
2.4mm	.800	35	12 - 90	12 - 180
2.4mm	1.100	45	15 - 150	15 - 250
3.2mm	1.100	60	20 - 200	20 - 300
3.2mm	1.500	90	25 - 250	25 - 350

# TIG WELDING TORCHES

## ARC T4W Tig Torch 450 Amp

Liquid Cooled 450 Amp - Available in 4m, 8m Lengths

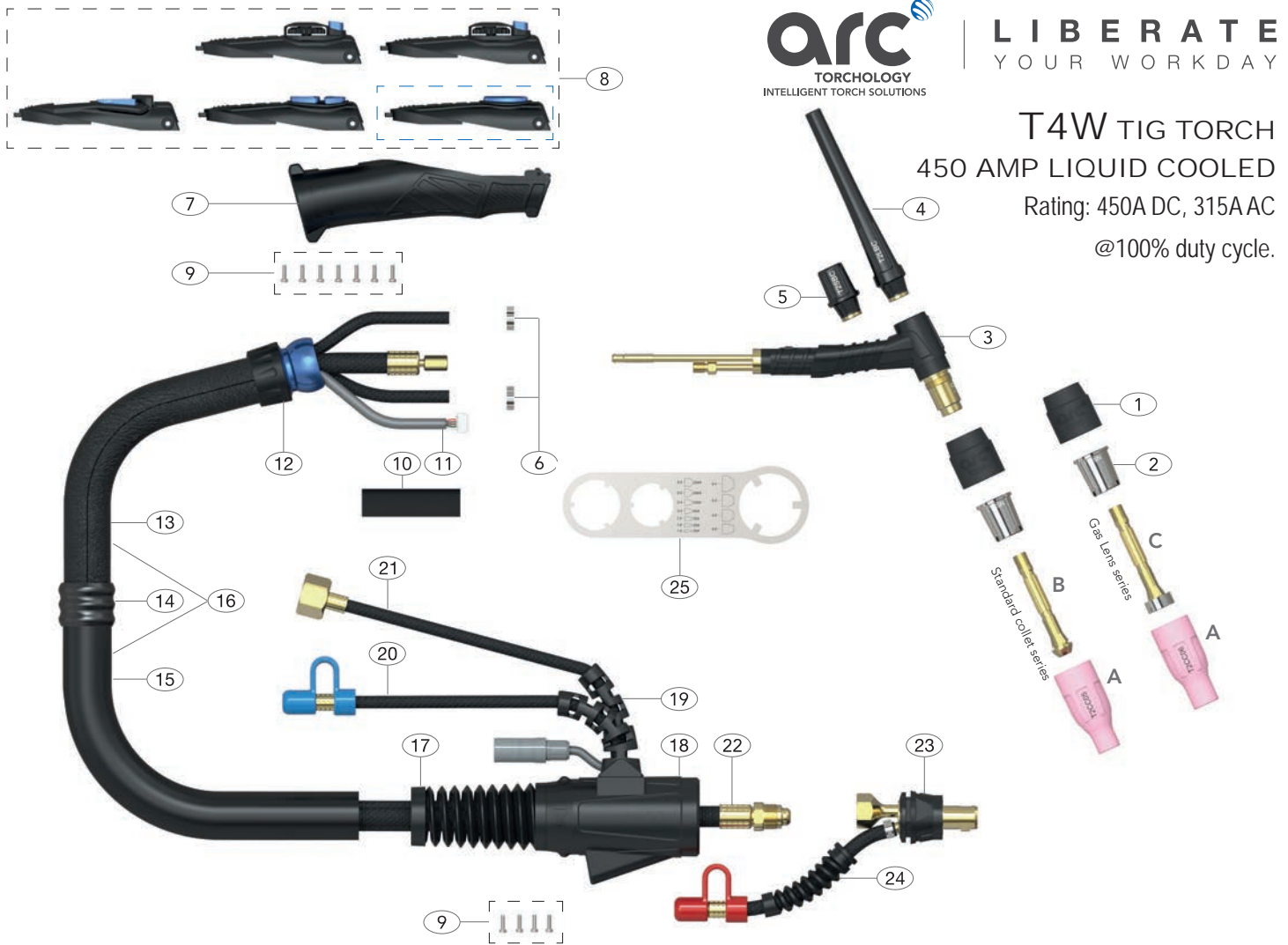

**arc**  
TORCHHOLOGY  
INTELLIGENT TORCH SOLUTIONS

**LIBERATE**  
YOUR WORKDAY

**T4W TIG TORCH**  
450 AMP LIQUID COOLED  
Rating: 450A DC, 315AAC  
@100% duty cycle.

Torch Model	Description	
	Part Number 4m	8m
ARC T3WTig Torch 35-50 Twistlok End, 2m Gas Hose	ARC-T3W-4M	ARC-T3W-8M

Spare Parts		
Part Number	Description	
1	T2GS	Head Gasket
2	T2SN	Heat Zone Isolator
3	AT4501	T3W/T4W Torch Body Water-Cooled
4	T2LBC	Long Back Cap
5	T2SBC	Short Back Cap
6	ATB5025S	Water Hose Clamp 8.0mm
7	ATERH200	Arc Handle Kit
8*	ATER1MS	Momentary Switch Kit
9	ATERSP1	Screw Pack
10	ATHS22MM-130	Heat Shrink Tube
11	ATERSWL4	Trigger Lead 4m
	ATERSWL8	Trigger Lead 8m
12	ATERKJ200	Knuckle Joint
13	ATERLC200-08	Leather Cover x 0.8m
14	ATERJK200	Joint Repair Kit
15	ATERNCL-32	Neoprene Cover Assembly x 3.2m
	ATERNCL-72	Neoprene Cover Assembly x 7.2m

Spare Parts		
Part Number	Description	
16	ATERCO200-40	Sheath x 4m Inc Leather Cover
	ATERCO200-80	Sheath x 8m Inc Leather Cover
17	ATSLH26-S	Cable Support Large
18	ATNSLH26-H	Surelok Housing Large
19	ATSLH1820-S	Surelok Housing Support
20	ATNSLH26-H	Surelok Housing Large
21	ATN45V07OB-WF#	Water Feed Hose x 4m O/B Rubber
	ATN45V08OB-WF#	Water Feed Hose x 8m O/B Rubber
22	AT4520-4M-OB	Power Cable x 4m Surelok O/B Rubber
	AT4520-8M-OB	Power Cable x 8m Surelok O/B Rubber
23	ATNSL3550	Surelok Body & Support
24	ATNSLOB-1-WR#	Water Return Hose O/B
25	AT-SP	Spanner

# TIG WELDING TORCHES

## ARC T4W Tig Torch 450 Amp

Front End Wear Parts - Collet Bodies, Ceramic Nozzles, Gas Lens Filters, Starter Kits



### Standard Front End Parts



Part #	Description	Size
T2CC04	Ceramic Cup Ø6mm	4
T2CC05	Ceramic Cup Ø8mm	4
T2CC06	Ceramic Cup Ø10mm	5
T2CC07	Ceramic Cup Ø11mm	6
T2CC08	Ceramic Cup Ø12.5mm	8
T2CC10	Ceramic Cup Ø16mm	10

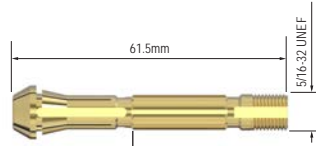

Part #	Description
T2CB10	Collet Body 1.0mm
T2CB16	Collet Body 1.6mm
T2CB24	Collet Body 2.4mm
T2CB32	Collet Body 3.2mm

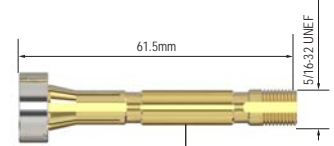

Part #	Description
T2GL10	Gas Lens Collet Body 1.0mm
T2GL16	Gas Lens Collet Body 1.6mm
T2GL24	Gas Lens Collet Body 2.4mm
T2GL32	Gas Lens Collet Body 3.2mm

### Gas Lens Body Filter Kits - Small



Part #	Description
SGL10FS-3KIT	ARC Small Gas Lens Body Filter Kit-1.0mm Ø (3 per Kit)
SGL16FS-3KIT	ARC Small Gas Lens Body Filter Kit-1.6mm Ø (3 per Kit)
SGL24FS-3KIT	ARC Small Gas Lens Body Filter Kit-2.4mm Ø (3 per Kit)
SGL32FS-3KIT	ARC Small Gas Lens Body Filter Kit-3.2mm Ø (3 per Kit)

### Gas Lens Body Starter Kits - Small

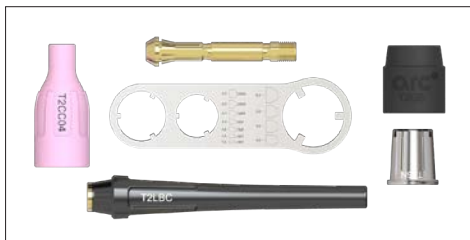

Part #	Description
SGL1	ARC Small Gas Lens Body Starter Kit 1.0mm Ø
SGL2	ARC Small Gas Lens Body Starter Kit 1.6mm Ø
SGL4	ARC Small Gas Lens Body Starter Kit 2.4mm Ø
SGL5	ARC Small Gas Lens Body Starter Kit 3.2mm Ø

# TIG WELDING TROUBLE SHOOTING

The following chart addresses some of the common problems of TIG welding. In all cases of equipment malfunction, the manufacturer's recommendations should be strictly adhered to and followed.

<b>1: Tungsten burning away quickly</b>	
<i>Possible Reason</i>	<i>Suggested Remedy</i>
Incorrect Gas	Check that pure Argon is being used
No gas	Check the gas cylinder contains gas and is connected
Inadequate gas flow	Check the gas is connected, check hoses, gas valve and torch are not restricted. Set the gas flow between 10 - 15 l/min flow rate
Back cap not fitted correctly	Make sure the torch back cap is fitted so that the o-ring is inside the torch body
Torch connected to DC +	Connect the torch to the DC- output terminal
Incorrect tungsten being used	Check and change the tungsten type if necessary
Tungsten being oxidised after weld is finished	Keep shielding gas flowing 10–15 seconds after arc stoppage. 1 second for each 10 amps of weld current.
Tungsten melting back into the nozzle on AC welding	Check that correct type of tungsten is being used. Check the balance control is not set too high on the balance - reduce to a lower setting
<b>2: Contaminated tungsten</b>	
<i>Possible Reason</i>	<i>Suggested Remedy</i>
Touching tungsten into the weld pool	Keep tungsten from contacting weld puddle. Raise the torch so that the tungsten is off of the work piece 2 - 5mm
Touching the filler wire to the tungsten	Keep the filler wire from touching the tungsten during welding, feed the filler wire into the leading edge of the weld pool in front of the tungsten
Tungsten melting into the weld pool	Check that correct type of tungsten is being used. Too much current for the tungsten size so reduce the amps or change to a larger tungsten
<b>3: Porosity - poor weld appearance and colour</b>	
<i>Possible Reason</i>	<i>Suggested Remedy</i>
Incorrect Gas	Check that pure Argon is being used
Inadequate gas flow / gas leaks	Check the gas is connected, check hoses, gas valve and torch are not restricted. Set the gas flow between 10 - 15 l/min flow rate. Check hoses and fittings for holes, leaks etc.,
Moisture on the base metal	Remove all moisture from base metal before welding
Contaminated base metal	Remove materials like paint, grease, oil, and dirt, including mill scale from base metal
Contaminated filler wire	Remove all grease, oil, or moisture from filler metal.
Incorrect filler wire	Check the filler wire and change if necessary
<b>4: Yellowish residue / smoke on the alumina nozzle &amp; discoloured tungsten</b>	
<i>Possible Reason</i>	<i>Suggested Remedy</i>
Incorrect Gas	Use pure Argon gas
Inadequate gas flow	Set the gas flow between 10 - 15 l/min flow rate
Inadequate post flow gas	Increase the post flow gas time
Alumina gas nozzle too small for size of tungsten being used	Increase the size of the alumina gas nozzle
<b>5: Unstable Arc during DC welding</b>	
<i>Possible Reason</i>	<i>Suggested Remedy</i>
Torch connected to DC +	Connect the torch to the DC- output terminal
Contaminated base metal	Remove materials like paint, grease, oil, and dirt, including mill scale from base metal.
Tungsten is contaminated	Remove 10mm of contaminated tungsten and re grind the tungsten
Arc length too long	Lower torch so that the tungsten is off of the work piece 2 - 5mm
<b>6: HF present but no welding power</b>	
<i>Possible Reason</i>	<i>Suggested Remedy</i>
Incomplete welding circuit	Check earth lead is connected. Check all cable connections. If using a water cooled torch check that the power cable is not separated.
No gas	Check the gas is connected and cylinder valve open, check hoses, gas valve and torch are not restricted. Set the gas flow between 10 - 15 l/min flow rate
Tungsten melting into the weld pool	Check that correct type of tungsten is being used. Too much current for the tungsten size so reduce the amps or change to a larger tungsten

## continued- TIG WELDING TROUBLE SHOOTING

<b>7: Arc wanders during DC welding</b>	
<i>Possible Reason</i>	<i>Suggested Remedy</i>
Poor gas flow	Check and set the gas flow between 10 - 15 l/min flow rate
Incorrect arc length	Lower torch so that the tungsten is off of the work piece 2 - 5mm
Tungsten incorrect or in poor condition	Check that correct type of tungsten is being used. Remove 10mm from the weld end of the tungsten and re sharpen the tungsten
Poorly prepared tungsten	Grind marks should run lengthwise with tungsten, not circular. Use proper grinding method and wheel.
Contaminated base metal	Remove contaminating materials like paint, grease, oil, and dirt, including mill scale from base metal.
Contaminated filler wire	Remove all grease, oil, or moisture from filler metal.
Incorrect filler wire	Check the filler wire and change if necessary
<b>8: Arc difficult to start or will not start DC welding</b>	
<i>Possible Reason</i>	<i>Suggested Remedy</i>
Incorrect machine set up	Check machine set up is correct
No gas, incorrect gas flow	Check the gas is connected and cylinder valve open, check hoses, gas valve and torch are not restricted. Set the gas flow between 10 - 15 l/min flow rate
Tungsten is contaminated	Remove 10mm of contaminated tungsten and re grind the tungsten
Incorrect tungsten size and or tungsten being used	Check and change the size and or the tungsten if required
Loose connection	Check all connectors and tighten
Earth clamp not connected to work	Connect the earth clamp directly to the work piece wherever possible
Loss of high frequency	Check torch and cables for cracked insulation or bad connections. Check spark gaps and adjust if necessary

# MMA (Stick) WELDING TROUBLE SHOOTING

The following chart addresses some of the common problems of MMA welding. In all cases of equipment malfunction, the manufacturer's recommendations should be strictly adhered to and followed.

<b>1: No arc</b>	
Possible Reason	Suggested Remedy
Incomplete welding circuit	Check earth lead is connected. Check all cable connections.
Wrong mode selected	Check the MMA selector switch is selected
No power supply	Check that the machine is switched on and has a power supply
<b>2: Porosity – small cavities or holes resulting from gas pockets in weld metal.</b>	
Possible Reason	Suggested Remedy
Arc length too long	Shorten the arc length
Work piece dirty, contaminated or moisture	Remove moisture and materials like paint, grease, oil, and dirt, including mill scale from base metal
Damp electrodes	Use only dry electrodes
<b>3: Excessive Spatter</b>	
Possible Reason	Suggested Remedy
Amperage too high	Decrease the amperage or choose a larger electrode
Arc length too long	Shorten the arc length
<b>3: Weld sits on top, lack of fusion</b>	
Possible Reason	Suggested Remedy
Insufficient heat input	Increase the amperage or choose a larger electrode
Work piece dirty, contaminated or moisture	Remove moisture and materials like paint, grease, oil, and dirt, including mill scale from base metal
Poor welding technique	Use the correct welding technique or seek assistance for the correct technique
<b>4: Lack of penetration</b>	
Possible Reason	Suggested Remedy
Insufficient heat input	Increase the amperage or choose a larger electrode
Poor welding technique	Use the correct welding technique or seek assistance for the correct technique
Poor joint preparation	Check the joint design and fit up, make sure the material is not too thick. Seek assistance for the correct joint design and fit up
<b>5: Excessive penetration - burn through</b>	
Possible Reason	Suggested Remedy
Excessive heat input	Reduce the amperage or use a smaller electrode
Incorrect travel speed	Try increasing the weld travel speed
<b>6: Uneven weld appearance</b>	
Possible Reason	Suggested Remedy
Unsteady hand, wavering hand	Use two hands where possible to steady up, practise your technique
<b>7: Distortion – movement of base metal during welding</b>	
Possible Reason	Suggested Remedy
Excessive heat input	Reduce the amperage or use a smaller electrode
Poor welding technique	Use the correct welding technique or seek assistance for the correct technique
Poor joint preparation and or joint design	Check the joint design and fit up, make sure the material is not too thick. Seek assistance for the correct joint design and fit up
<b>7: Electrode welds with different or unusual arc characteristic</b>	
Possible Reason	Suggested Remedy
Incorrect polarity	Change the polarity, check the electrode manufacturer for correct polarity



# ATTENTION! - CHECK FOR GAS LEAKS

At initial set up and at regular intervals we recommend to check for gas leakage. Recommended procedure is as follows:

1. Connect the regulator and gas hose assembly and tighten all connectors and clamps.
2. Slowly open the cylinder valve.
3. Set the flow rate on the regulator to approximately 8-10 l/min.
4. Close the cylinder valve and pay attention to the needle indicator of the contents pressure gauge on the regulator, if the needle drops away towards zero there is a gas leak.  
Sometimes a gas leak can be slow and to identify it will require leaving the gas pressure in the regulator and line for an extended time period. In this situation it is recommended to open the cylinder valve, set the flow rate to 8-10 l/min, close the cylinder valve and check after a minimum of 15 minutes.
5. If there is a gas loss then check all connectors and clamps for leakage by brushing or spraying with soapy water, bubbles will appear at the leakage point.
6. Tighten clamps or fittings to eliminate gas leakage.

**Important:** We strongly recommend that you check for gas leakage prior to operation of your machine. We recommend that you close the cylinder valve when the machine is not in use.

**Esseti NZ Ltd, authorised representatives or agents of Esseti NZ Ltd will not be liable for the loss of any gas.**

## ESSETI (NZ) LIMITED WARRANTY POLICY

We understand that sometimes you may need to return a product that you have purchased from our Esseti NZ Ltd.

Authorised Distributor Network. To assist you, we have set out below the Esseti NZ Ltd Warranty Returns Policy that you should know about. These terms and conditions supersede and exclude all former and other representations and arrangements relating to any warranties on these products, irrespective of whether expressed or implied.

ESSETI New Zealand Limited ('us', 'we') warrants that the products bearing the brand names ESSETI, XCEL-ARC, RAZORWELD, RAZORCUT, JASIC, VIPER, T&R, XCEL-GAS, Otos, Servore, TECNA & HIT-8SS supplied by us and purchased by you from an Authorised ESSETI (NZ) Ltd. Distributor are free of Material and Faulty Workmanship Defects except for those products listed under 'Warranty Exclusions' and whilst any claim is made subject to the following terms and conditions.

Your rights under the New Zealand Consumer Law may not be limited by a defined time. However, New Zealand Consumer Law does recognise that the relevant time period can vary from product to product, depending on factors such as the nature of the product and the price. Esseti NZ Ltd. adopts the same approach. As you can appreciate, the type of remedy we can offer you may also vary depending on how long it takes you to return the product to us.

### WARRANTY PERIOD

We offer the following 'Warranty Periods' effective from the 'date of purchase':

- XCEL-ARC, Inverter MIG/SWF/MTS, MMA/TIG, TIG ACDC, Plasma (Power Source Only*)	2 Years
- RAZORWELD, Inverter MIG/SWF/MTS, MMA/TIG, TIG ACDC (Power Source Only*)	3 Years
- VIPER, ARC140, AARC160, TIG200P, MIG150, CUT30 (Power Source Only*)	1 Year
- VIPER, MIG185, TIG200ACDC (Power Source Only*)	2 Years
- RAZORCUT, Inverter Plasma (Power Source Only*)	2 Years
- JASIC, Inverter MIG/SWF/MTS, MMA/TIG, TIG ACDC, Plasma (Power Source Only*)	2 Years
- XCEL-ARC & RAZORWELD, Water Coolers, PAPR Air Blower Unit	1 Year
- XCEL-GAS, Gas Cutting and Welding Torches	3 Months
- XCEL-GAS, Straight Line & Gas Cutting Machines (Power Source Only*)	1 Year
- XCEL-GAS, Regulators Argon/ Acetylene / Oxygen / LPG / Bobbin Flowmeter	1 Year
- XCEL-ARC, Automatic Welding Helmet	2 Years
- RAZORWELD, Automatic Welding Helmets / Goggles	1 Year
- TECNA, Spot Welding Machines (Power Source Only*)	1 Year
- HIT-8SS, Automatic Carriage (Power Source Only*)	1 Year
- ALL WELDING TORCHES – GMAW / GTAW / MMAW / PLASMA	3 Months
- ALL EARTH LEADS, INTERCONNECTING CABLES, GAS HOSES	3 Months

(\* This only covers manufacturing faults on any torches, cables and other accessories, either included with a machine kitset or sold separately, for the first three months after date of purchase.

### WARRANTY / RETURNS / EXCHANGES

Our Warranty Returns Policy recognises all and any rights you have under New Zealand Consumer Law and other relevant laws.

You shall inspect the goods on delivery and shall within seven (7) days of delivery (time being of the essence) notify the Esseti NZ Ltd. Authorised Distributor from whom you purchased the goods of any alleged defect, shortage in quantity, damage or failure to comply with the description or quote.

You shall also afford Esseti NZ Ltd. the opportunity to inspect the goods within a reasonable time following delivery if you believe the goods are defective in any way.

If you shall fail to comply with these provisions the goods shall be presumed to be free from any defect or damage.

For defective goods and where permissible by law, Esseti NZ Ltd. reserves the right to repair or otherwise remedy the defect prior to issuing replacement goods or refunding the purchase price.

If the goods are being purchased for a business purpose then the purchaser acknowledges that the Consumer Guarantees Act will not apply.

The New Zealand Sales of Goods Act applies when goods are not covered by the Consumer Guarantees Act. You may be able to get a full refund or compensation if the trader doesn't have the right to sell the goods, or the goods are:

- not of 'merchantable quality' (so defective that most people wouldn't want them)
- not fit for their normal purpose
- poorer quality than a sample you were shown
- not suitable for what you told the trader you wanted the goods for
- not matching their description

If there has been a misrepresentation you may have rights under the Fair Trading Act or the Contractual Remedies Act and therefore also entitled to, at the consumer's discretion, either a refund of the purchase price of the goods, or repair of the goods, or replacement of the goods.

Returns will only be accepted provided that:

- (a) You have complied with the provisions outlined above, and
- (b) where the goods are unable to be repaired, the goods are returned at your cost within thirty (30) days of the delivery date, and
- (c) Esseti NZ Ltd. will not be liable for goods which have not been stored or used in a proper manner, and
- (d) the goods are returned in the condition in which they were delivered and with all packaging material, brochures and instructional material in as new condition as is reasonably possible in the circumstances.

Esseti NZ Ltd. Accepts no responsibility for any products lost, damaged or mislaid whilst in transit. Esseti NZ Ltd. may (at their sole discretion) accept the return of goods for credit but this may incur a handling fee of up to fifteen percent (15%) of the value of the returned Goods plus any freight costs.

### MAKING A CLAIM

If you wish to make a claim under this Warranty, you should:

- Return the product to the point of purchase either in person or via prepaid courier; or
- Contact us by Telephone - Esseti NZ Ltd, **06 355 1103**

When returned, the product must be accompanied with the original Receipt or Tax Invoice clearly showing the purchase date and disclosing the purchase price. All costs of installation, cartage, freight, travelling expenses, hiring tools and insurance are paid by the Customer. To the extent permitted by law, our total liability for loss or damage of every kind related to the goods in any way whatsoever is limited to the amount paid to the retailer by you for the goods or the value of the goods. No responsibility will be taken for any products lost, damaged or mislaid whilst in transit.

### WARRANTY EXCLUSIONS

This Warranty covers Material and Faulty Workmanship defects only. This Warranty does not cover damage caused by:

- Normal wear and tear due to usage
- Misuse or abusive use of the machine and/or failure to correctly follow set up or operating instructions supplied with these products
- Failure to clean or improper cleaning of the product
- Failure to maintain the equipment such as regular services, etc.
- Incorrect voltage or non-authorized electrical connections
- Improper installation
- Use of non-authorized/non-standard parts
- Abnormal product performance caused by any ancillary equipment interference or other external factors
- Failure or any breakage caused by overload, dropping or abusive treatment or use by the customer
- Repair, modifications or other work carried out on the product other than by an Esseti-Authorised Service Agent

Unless it is a manufacturing fault, this Warranty does not cover the following parts:

- **All Batteries, including Button Type and Cell Type Batteries**
- **MIG Welding Torch Consumables, such as:**  
Gas Nozzles, Gas Diffusers, Contact Tip Holders, Contact Tips, Swan Necks, Triggers, Handles, Liners, Euro Block, Shroud Springs, Knobs, All XCEL-ARC / Magmaweld Mig Welding Wires & Electrodes, Arc Leads, Welding Cable, Electrode Holder, Earth Clamps
- **MMA & TIG Welding Torch Consumables, such as:**  
Tungsten Electrodes, Collet, Collet Body, Alumina Nozzle, Torch Head, Torch Head water Cooled, Torch Head Flexible, Back Caps, Gas Lens, Torch Handle, Cup Gasket, Torch Body Gas Valve, O-ring, All XCEL-ARC TIG Welding Rods, All XCEL-ARC / Magmaweld Electrodes, Arc Leads, Welding Cable, Electrode Holder, Earth Clamps
- **PLASMA Cutting Torches Consumables, such as:**  
All Cutting Tips, All Diffuser/Swirl Ring, All Electrodes, Retaining Caps, Nozzle Springs, All Spacers, All Shield Caps, All Air and Power Cables, All Switches, All O-rings, All Springs, All Circle Guides and Cutting Kits, Torch Bodies, Air Filter Regulator, Welding Cable, Earth Clamps
- **Gas Welding & Cutting Torch and Straight Line Cutting Machine Consumables and Fittings, such as:**  
All Cutting, Welding & Brazing Tips, Adaptors, Hoses, Fittings, Tracks and associated parts
- **Automatic Welding & Cutting Carriage Machine Parts, such as:**  
Input Cord, Inter-connecting Power Cord, Triggering Cable

**This Warranty does not cover products purchased:**

- Without the provision of a suitable Receipt or Tax Invoice that clearly provides proof of purchase as outlined above
- At an auction or from a private seller
- Unless it is a manufacturing fault, this Warranty does not apply to any products sold to Hire Companies.

These conditions may only be varied with the written approval of the Directors of Esseti NZ Limited.

**REMEMBER TO RETAIN YOUR ORIGINAL INVOICE FOR PROOF OF PURCHASE.**

**eseti**  
New Zealand Limited

**XA**  
XCEL-ARC

**RazorWeld**

**RazorCut**

 **VIPER**